

FM Stereo / RDS

Option for R&S[®]Signal Generators

Operating Manual



1171.6050.12 – 10

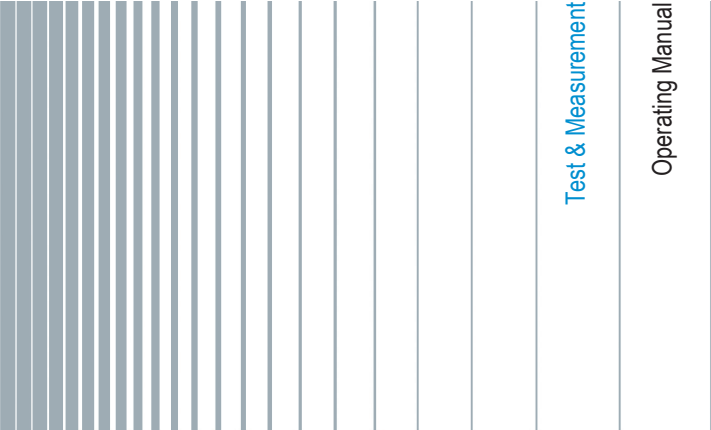

Test & Measurement

Operating Manual

This document describes the following software options:

- R&S®AMU-K57
1403.4102.02
- R&S®SMATE-K57
1400.6450.02
- R&S®SMBV-K57
1415.8190.xx
- R&S®SMJ-K57
1403.6350.02
- R&S®SMU-K57
1403.6250.02

This manual version corresponds to firmware version:

FW 3.20.281.xx and later of the R&S®SMBV100A

FW 2.20.360.142 and later of the R&S®SMU200A, R&S®SMATE200A, R&S®SMJ100A and R&S®AMU200A

© 2015 Rohde & Schwarz GmbH & Co. KG

Mühlhofstr. 15, 81671 München, Germany

Phone: +49 89 41 29 - 0

Fax: +49 89 41 29 12 164

Email: info@rohde-schwarz.com

Internet: www.rohde-schwarz.com

Subject to change – Data without tolerance limits is not binding.

R&S® is a registered trademark of Rohde & Schwarz GmbH & Co. KG.

Trade names are trademarks of the owners.

The following abbreviations are used throughout this manual: R&S®AMU200A is abbreviated as R&S AMU, R&S®SMATE200A is abbreviated as R&S SMATE, R&S®SMBV100A is abbreviated as R&S SMBV, R&S®SMJ100A is abbreviated as R&S SMJ, R&S®SMU200A is abbreviated as R&S SMU, R&S®WinIQSIM2™ is abbreviated as R&S WinIQSIM2

Contents

1	Preface	5
1.1	Documentation Overview.....	5
1.2	Typographical Conventions.....	6
1.3	Notes on Screenshots.....	7
2	Introduction	9
2.1	Modulation System FM-Stereo.....	9
2.2	Baseband Coding and Group Structure.....	10
3	FM-Stereo User Interface	15
3.1	Main Settings	15
3.1.1	General Settings.....	16
3.1.2	Audio Settings.....	17
3.1.3	Stereo Pilot Tone Settings.....	21
3.1.4	RDS/RBDS Parameters.....	22
3.2	RDS/RBDS Configuration	22
3.3	RDS/RBDS Groups Message Settings	24
3.3.1	General Settings.....	25
3.3.2	Common Settings.....	25
3.3.3	Group Type 0A .. 15B Settings.....	27
3.3.4	Group Table.....	30
3.4	Extended Configuration	31
3.4.1	Group Type 0 - Extended Configuration.....	31
3.4.2	Group Type 4A - Extended Configuration.....	33
3.4.3	Group Type 14 - Extended Configuration.....	35
3.4.3.1	Alternative Frequencies.....	36
3.4.3.2	Mapped Frequencies.....	36
3.4.4	Group Type 15 - Extended Configuration.....	42
3.5	RDS/RBDS User Message Table - Group 0A .. 15B	43
3.6	RDS/RBDS Group Hex Table	44
3.7	Trigger	45
3.7.1	Trigger In.....	46
3.7.2	Global Settings.....	46

4 Remote-Control Commands.....	49
4.1 Primary Commands.....	50
4.2 RDS/RBDS Configurations.....	58
4.3 Group Hex Settings.....	61
4.4 RDS/RBDS Group Settings.....	63
List of Commands.....	85
Index.....	87

1 Preface

1.1 Documentation Overview

The user documentation for the R&S Signal Generator consists of the following parts:

- Online Help system on the instrument,
- "Quick Start Guide" printed manual,
- Documentation CD-ROM with:
 - Online help system (*.chm) as a standalone help,
 - Operating Manuals for base unit and options,
 - Service Manual,
 - Data sheet and specifications,
 - Links to useful sites on the R&S internet.

Online Help

The Online Help is embedded in the instrument's firmware. It offers quick, context-sensitive access to the complete information needed for operation and programming. The online help contains help on operating the R&S Signal Generator and all available options.

Quick Start Guide

The Quick Start Guide is delivered with the instrument in printed form and in PDF format on the Documentation CD-ROM. It provides the information needed to set up and start working with the instrument. Basic operations and an example of setup are described. The manual includes also general information, e.g., Safety Instructions.

Operating Manuals

The Operating Manuals are a supplement to the Quick Start Guide. Operating Manuals are provided for the base unit and each additional (software) option.

These manuals are available in PDF format - in printable form - on the Documentation CD-ROM delivered with the instrument. In the Operating Manual for the base unit, all instrument functions are described in detail. Furthermore, it provides an introduction to remote control and a complete description of the remote control commands with programming examples. Information on maintenance, instrument interfaces and error messages is also given.

In the individual option manuals, the specific functions of the option are described in detail. For additional information on default settings and parameters, refer to the data sheets. Basic information on operating the R&S Signal Generator is not included in the option manuals.

Service Manual

The Service Manual is available in PDF format - in printable form - on the Documentation CD-ROM delivered with the instrument. It describes how to check compliance with rated specifications, on instrument function, repair, troubleshooting and fault elimination. It contains all information required for repairing the instrument by the replacement of modules.

This manual can also be orderd in printed form (see ordering information in the data sheet).

Release Notes

The release notes describe new and modified functions, eliminated problems, and last minute changes to the documentation. The corresponding firmware version is indicated on the title page of the release notes. The current release notes are provided in the Internet.

Web Help

The web help provides online access to the complete information on operating the R&S Signal Generator and all available options, without downloading. The content of the web help corresponds to the user manuals for the latest product version.

The web help is available on the R&S Signal Generator product page at the Downloads > Web Help area.

Application Notes

Application notes, application cards, white papers and educational notes are further publications that provide more comprehensive descriptions and background information.

The latest versions are available for download from the Rohde & Schwarz website, at <http://www.rohde-schwarz.com/appnotes>.

1.2 Typographical Conventions

The following text markers are used throughout this documentation:

Convention	Description
"Graphical user interface elements"	All names of graphical user interface elements on the screen, such as dialog boxes, menus, options, buttons, and softkeys are enclosed by quotation marks.
KEYS	Key names are written in capital letters.
File names, commands, program code	File names, commands, coding samples and screen output are distinguished by their font.
<i>Input</i>	Input to be entered by the user is displayed in italics.

Convention	Description
Links	Links that you can click are displayed in blue font.
"References"	References to other parts of the documentation are enclosed by quotation marks.

1.3 Notes on Screenshots

When describing the functions of the product, we use sample screenshots. These screenshots are meant to illustrate as much as possible of the provided functions and possible interdependencies between parameters. The shown values may not represent realistic test situations.

The screenshots usually show a fully equipped product, that is: with all options installed. Thus, some functions shown in the screenshots may not be available in your particular product configuration.

2 Introduction

The R&S Signal Generator enables you to generate signals in accordance with the United States Radio Broadcast Data System (RBDS) standard and the European standard CENELEC EN50067 "Specification of the Radio Data System (RDS) for VHF/FM Sound Broadcasting in the frequency Range from 87.5 to 108.0 MHz".

The R&S Signal Generator simulates FM-STEREO signal at the physical layer. The following list gives an overview of the main options provided by the R&S Signal Generator for generating a FM-STEREO signal in accordance with the RDS/RBDS standard:

- Generation of standard compliant FM-Stereo signal with Stereo audio signal and RDS/RBDS signal
- Full configuration of all group types and versions
- Internal modulation sources from LF Generator and wave file for digital stereo signal
- External modulation sources from digital S/P DIF interface for digital stereo signal
- In case of two path instrument, simulation of two independent FM radio transmitters
- Configuration of other networks and alternative frequency list

2.1 Modulation System FM-Stereo

The figure below shows the stereophonic multiplex containing the data signal.

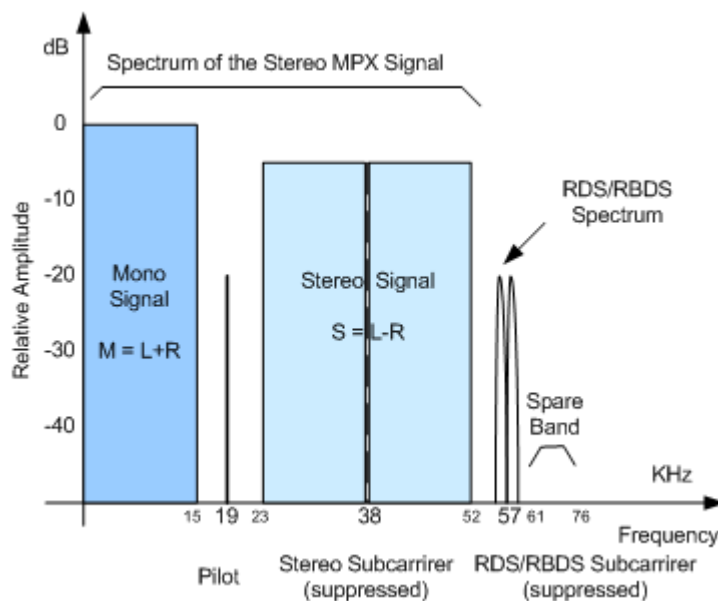

Fig. 2-1: FM baseband spectrum including RDS/RBDS subcarrier

The radio frequency signal consists of a frequency modulated carrier with frequency of 19 kHz and maximum frequency deviation of 80 kHz.

The stereophonic multiplex signal consists of a mono signal, the sidebands of the stereo signal with suppressed subcarrier at 38 kHz and a pilot signal with exactly one half of the subcarrier frequency.

The mono signal M is the sum of the left-hand signal L and the right-hand signal R. The stereo signal S is the difference between the signals L and R. A pre-emphasis can be applied to both L and R signal prior to stereo coding.

The RDS/RBDS subcarrier is locked to the third harmonic of the 19 kHz pilot tone and suppressed.

The R&S Signal Generator enables you to configure the pilot's phase and frequency deviation, the RDS/RBDS subcarrier's phase and frequency deviation and the pre-emphasis. The pilot's phase and the RDS/RBDS subcarrier phase are set with respect to the 38 kHz subcarrier.

The figure below shows the FM-Stereo block diagram.

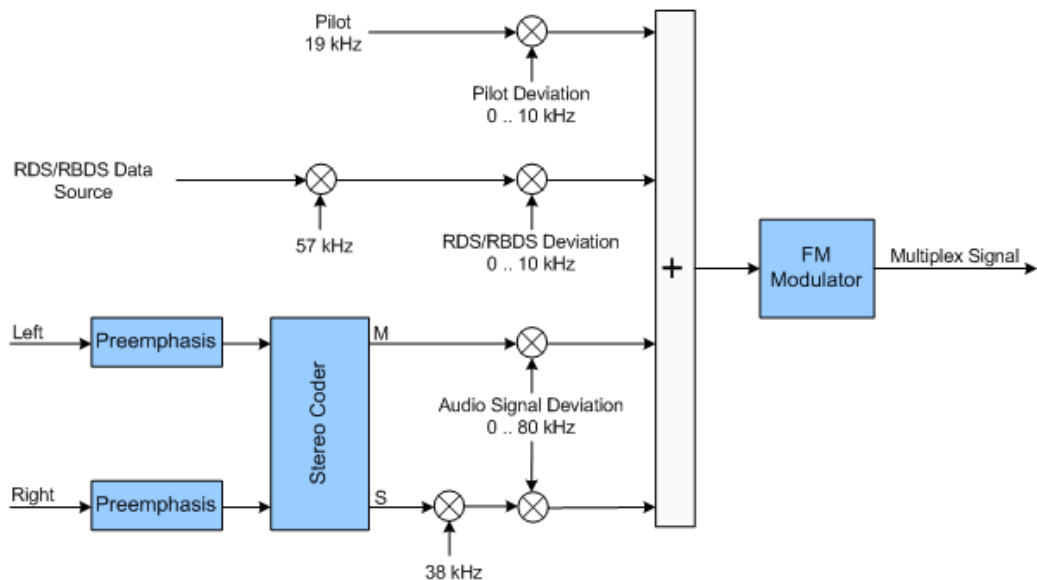

Fig. 2-2: FM-Stereo block diagram

2.2 Baseband Coding and Group Structure

The figure below shows the baseband coding principle.

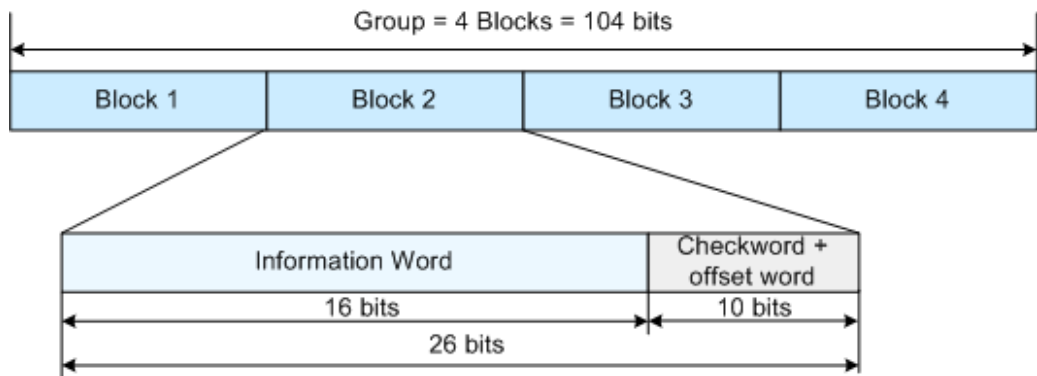

Fig. 2-3: Structure of the baseband coding

The basic element in the signal structure is the group. There are 16 groups (0 to 15) with 104 bits each. Each group consists of 4 blocks, 26 bits each. A block comprises an information word (16 bits) and a check word (10 bits).

Each group has two versions, version A and Version B. The figure below shows the group structure for both versions.

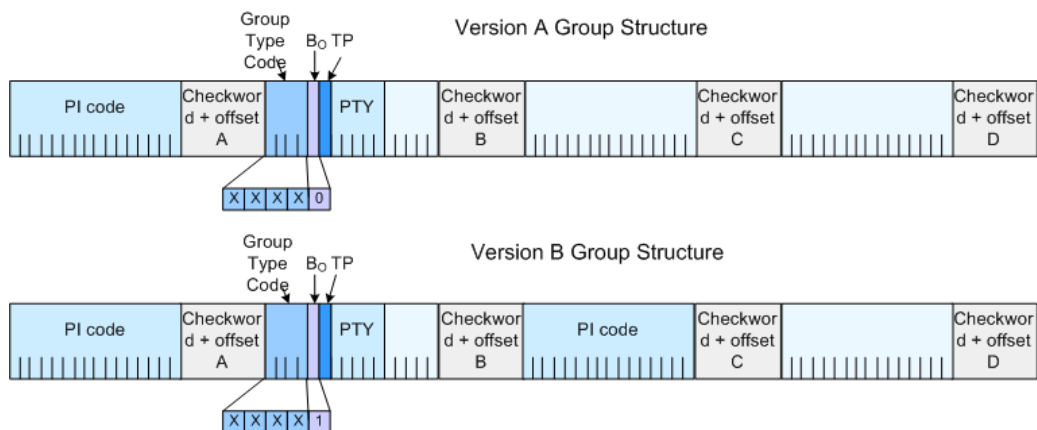

Fig. 2-4: Version A and B group format

The table below gives an overview of the available frame formats per Group Type and Group Type Version. The frame format is displayed in the "RDS/RBDS User Message Table" dialog of the corresponding group type and group type version

Table 2-1: Frame Formats per Group Type and Group Type Version

Group Type	Frame Format for Group Type Version A	Frame Format for Group Type Version B
0		
1		

Group Type	Frame Format for Group Type Version A	Frame Format for Group Type Version B
2		
3		
4		
5		
6		
7		
8		
9		
10		
11		
12		

Group Type	Frame Format for Group Type Version A	Frame Format for Group Type Version B
13		
14		
15		

3 FM-Stereo User Interface

The menu for setting the FM-Stereo digital standard is either called from the baseband block or from the menu tree under "Baseband."

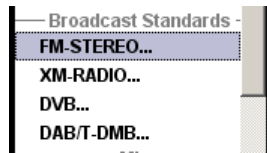

The screenshots provided in this description show parameter values that have been selected to illustrate as much as possible of the provided functions and possible inter-dependencies between them.

These values are not necessarily representative of realistic test situations.

3.1 Main Settings

The menu is split into several sections for configuring the standard.

The upper menu section is where the FM-Stereo digital standard is activated and deactivated and the FM deviation is set. Configuration settings can be stored and already stored configuration settings can be loaded.

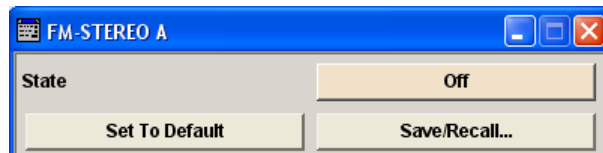

In the next two sections, the audio and stereo pilot tone settings are selected.

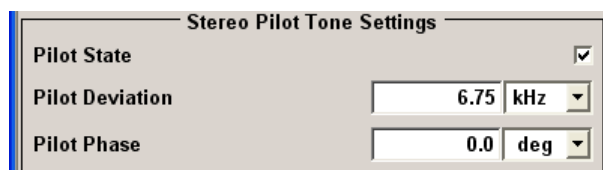
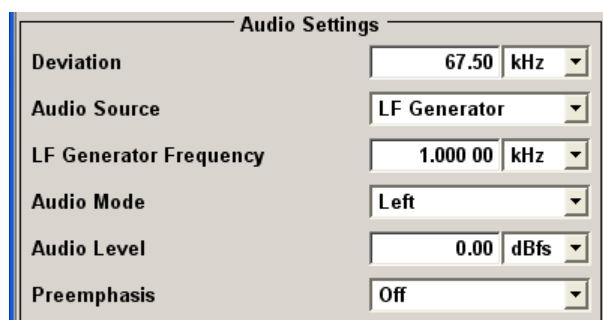

The buttons in the lower menu section lead to submenus for setting the trigger parameters and RDS/RBDS parameters.

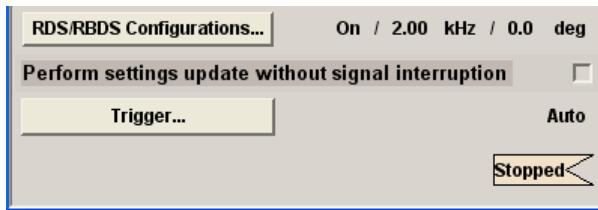

3.1.1 General Settings

State

Activates the standard and deactivates all the other digital standards and digital modulation modes in the same path.

Remote command:

[\[:SOURce<hw>\]:BB:STEReo:STATe](#) on page 50

Set To Default

Calls the default settings. The values of the main parameters are listed in the following table.

Parameter	Value
State	Not affected by "Set To Default"
Deviation	67 500 Hz
Audio Source	Off
Audio Mode	Mono Left
Audio Level	0 dBfs
Preemphasis	Off
Pilot State	On
Pilot Deviation	6750 Hz
Pilot Phase	0 deg
RDS/RBDS Configuration	On / 2.00 kHz / 0 deg
Trigger	Auto
Perform settings update without signal interruption	On

Remote command:

[\[:SOURce<hw>\]:BB:STEReo:PRESet](#) on page 51

Save/Recall..

Calls the "Save/Recall" menu.

From the "Save/Recall" menu, the "File Select" windows for saving and recalling FM-STEREO configurations and the "File Manager" is called.



FM-STEREO configurations are stored as files with the predefined file extension * . fm. The file name and the directory they are stored in are user-definable.

The complete settings in the "FM-STEREO" menu are saved and recalled.

"Recall FM-STEREO Setting"

Opens the "File Select" window for loading a saved FM-STEREO configuration.

The configuration of the selected (highlighted) file is loaded by pressing the "Select" button.

"Save FM-STEREO Setting"

Opens the "File Select" window for saving the current FM-STEREO signal configuration.

The name of the file is specified in the "File Name" entry field. The file is saved by pressing the Save button.

"File Manager"

Calls the "File Manager".

The "File Manager" is used to copy, delete, and rename files and to create new directories.

Remote command:

[\[:SOURCE<hw>\]:BB:STEREO:SETTING:CATALOG?](#) on page 51

[\[:SOURCE<hw>\]:BB:STEREO:SETTING:LOAD](#) on page 51

[\[:SOURCE<hw>\]:BB:STEREO:SETTING:STORE](#) on page 52

3.1.2 Audio Settings

In the "Audio Settings" section, the source for the audio signal and the preemphasis are selected.

Deviation

Sets the frequency deviation of the audio signal, i.e. the deviation of the mono signal M and the stereo signal S (see [figure 2-2](#)).

Remote command:

[\[:SOURCE<hw>\]:BB:STEREO:DEVIATION](#) on page 52

Audio Source

Selects the audio source for the FM-Stereo signal.

The sources cannot be used simultaneously.

"Off" The audio source is switched off.

"Extern S/P-DIF"

Activates the S/P-DIF input for the external digital modulation signals.

For R&S SMBV instruments:

The audio source for has to be connected to the CLK IN connector on the rear panel.

For R&S SMU, R&S SMJ, R&S SMATE and R&S AMU instruments:

The audio source for path A/B has to be connected respectively to the USER1/2 connector on the rear panel. The parameters "Map Out-

put Connector User 1 (BNC) / User 2 (AUX I/O) To" in the "User Marker/ AUS I/O" dialog have to be set to General Purpose Input.

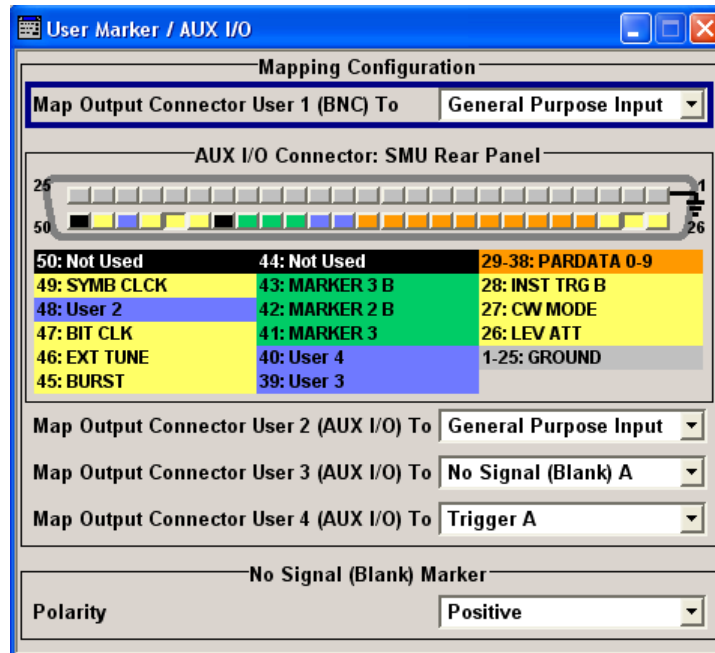

Note: Applying audio signal to the S/P-DIF interface. For proper signal processing, the instrument requires an S/P-DIF source with input level of minimum 2.000 V and the following settings:

- "Extern Clock Source"
- "Global Trigger/Clock/External Inputs > Threshold Trigger/Control Input = 0.01V"
- "Global Trigger/Clock/External Inputs > Impedance Trigger/Control Input = 50 Ohm"

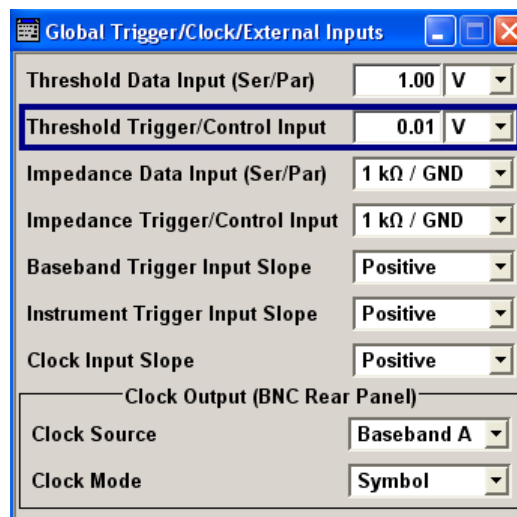

"LF-Generator"

The audio source is generated by the internal LF generator. The frequency of the LF generator is set with the parameter [LF Generator Frequency](#).

"Waveform Audio File"

A WAV-File can be selected. Audio files are selected in the [Load Audio File](#) menu.

Remote command:

[\[:SOURCE<hw>\]:BB:STEReo:SOURCE](#) on page 53

External Clock

Sets the external clock (44.1 or 48 kHz) in case an external S/P-DIF audio source is selected.

Remote command:

[\[:SOURCE<hw>\]:BB:STEReo:AUDio:EXTClock](#) on page 54

Load Audio File

Opens the "Load Audio File" menu to select the WAV-File.

Remote command:

[\[:SOURCE<hw>\]:BB:STEReo:AUDio:DSElect](#) on page 54

LF Generator Frequency

Sets the frequency of the LF-Generator in case a LF-Generator is selected as audio source.

Remote command:

[\[:SOURCE<hw>\]:BB:STEReo:AUDio\[:FREQuency\]](#) on page 56

Audio Mode

Sets the way the stereo audio source is mapped in case of mono or stereo operating mode.

"Left"

Audio signal only in the left-hand channel.

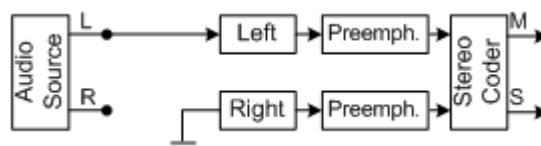

"Right"

Audio signal only in the right-hand channel.

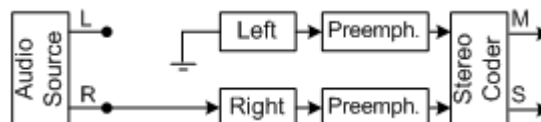

"Stereo Left=Right"

Audio signal of same frequency and phase in both channels.

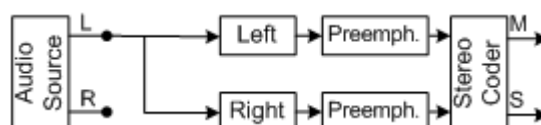

"Stereo Left=-Right"

Audio signal of same frequency but opposite phase in both channels.

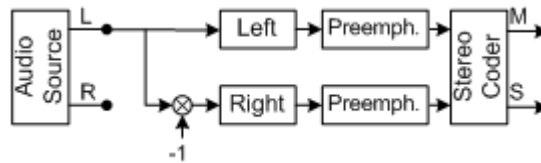
**"True Stereo"**

Audio signal with true stereo quality, i.e. different and independent signals in both channels.

This audio mode is not possible for audio source LF Generator.

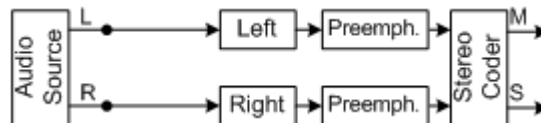

Remote command:

[\[:SOURCE<hw>\]:BB:STEReo:AUDio:MODE](#) on page 55

Audio Level

Sets the level of the audio signal.

Remote command:

[\[:SOURCE<hw>\]:BB:STEReo:AUDio:LEVel](#) on page 54

Preemphasis

Enables/disables and sets the preemphasis parameter value to 50 us or 75 us.

Remote command:

[\[:SOURCE<hw>\]:BB:STEReo:AUDio:PREemphasis](#) on page 55

3.1.3 Stereo Pilot Tone Settings

Pilot State

Enables/disables the 19 kHz pilot tone.

Stereo operating mode is possible with enabled pilot tone only.

Remote command:

[\[:SOURCE<hw>\]:BB:STEReo:PILot:STATe](#) on page 56

Pilot Deviation

Sets the frequency deviation of the pilot tone (see [figure 2-2](#)).

The parameter is enabled only for enabled pilot tone.

Remote command:

[\[:SOURCE<hw>\]:BB:STEReo:PILot\[:DEViation\]](#) on page 56

Pilot Phase

Sets the phase of the pilot tone (with respect to the 38 kHz subcarrier).

The parameter is enabled only for enabled pilot tone.

Remote command:

[:SOURce<hw>] :BB:STEReo:PILot:PHASe on page 56

3.1.4 RDS/RBDS Parameters

RDS/RBDS Configurations

Calls the "RDS/RBDS Configurations" menu for configuring the RDS/RBDS. The currently selected RDS/RBDS parameters state, deviation and phase are displayed next to the button.

The menu is described in [chapter 3.2, "RDS/RBDS Configuration"](#), on page 22.

Remote command:

n . a .

Perform settings update without signal interruption

Sets the way the FM signal is calculated in case of parameter update. If this parameter is enabled and some parameters are changed, these parameters are updated but the FM signal will not be interrupted.

Disabling the parameter results in automatically re-calculation of the FM signal after each parameter update. This will disturb the pilot and the receiver has to be re-synchronized.

Remote command:

[:SOURce<hw>] :BB:STEReo:PUWSint on page 57

Trigger...

Calls the menu for selecting the trigger mode and trigger source, for configuring the marker signals, and for setting the time delay of an external trigger signal.

This menu is described in [chapter 3.7, "Trigger"](#), on page 45.

The currently selected trigger mode and trigger source are is displayed next to the button.

Remote command:

n . a .

3.2 RDS/RBDS Configuration

The "RDS/RBDS Configuration" menu allows you to configure the RDS/RBDS data.

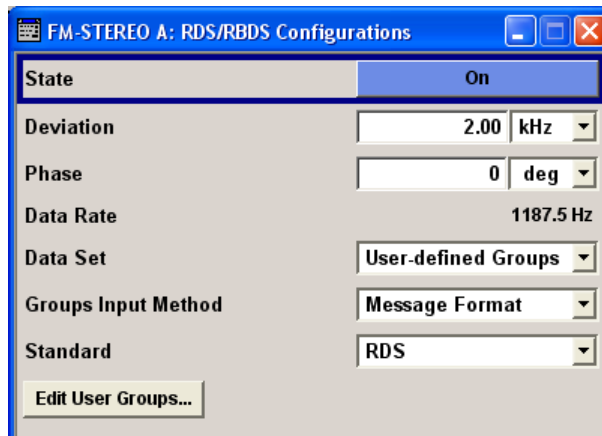
**State**

Activates/deactivates RDS/RBDS function.

Remote command:

[\[:SOURCE<hw>\]:BB:STEREO:DS:STATE](#) on page 61

Deviation

Sets the frequency deviation of the RDS/RBDS subcarrier (see [figure 2-2](#)).

Remote command:

[\[:SOURCE<hw>\]:BB:STEREO:DS:DEVIATION](#) on page 58

Phase

Selects the phase of the RDS/RBDS subcarrier (with respect to the 38 kHz subcarrier).

Remote command:

[\[:SOURCE<hw>\]:BB:STEREO:DS:PHASE](#) on page 60

Data Rate

Displays the RDS/RBDS data rate in Hz.

Remote command:

[\[:SOURCE<hw>\]:BB:STEREO:DS:DRATE?](#) on page 59

Data Set

Selects and activates the RDS/RBDS data set.

"User-defined Groups" The RDS/RBDS parameters in the "RDS/RBDS Groups Message Settings" or in the "RDS/RBDS Group Hex Table" menu can be configured by the user.

"Group List" The RDS/RBDS parameters can be loaded from a group list file. "Group List" can be generated internally in the data editor by means of the "Save Groups" button in "RDS/RBDS Groups Message Settings" menu.

The Group lists files have to have an extension `*.fm_gt`.

Group lists are selected in the "Load Group List" window, which is called by means of the "Select Group List" button.

Remote command:

`[:SOURce<hw>] :BB:STEReo:DS:DSET` on page 59

`[:SOURce<hw>] :BB:STEReo:DS:DSElect` on page 59

Groups Input Method

Selects the input format the RDS/RBDS parameters are represented for editing. There are two input formats: message format or hex table.

The parameter is enabled for data set "User-defined Groups" only.

Remote command:

`[:SOURce<hw>] :BB:STEReo:DS:GIM` on page 60

Standard

Selects the standard, RDS or RBDS, the signal is generated for.

Remote command:

`[:SOURce<hw>] :BB:STEReo:DS:MODE` on page 60

Edit User Group

Depending on the selection made for the parameter [Groups Input Method](#), calls the "RDS/RBDS Groups Message Settings" menu or the "RDS/RBDS Group Hex Table" menu for configuring the RDS/RBDS parameters.

The parameter is enabled for data set "User-defined Groups" only.

The menus are described in sections [chapter 3.3.1, "General Settings"](#), on page 25 and [chapter 3.6, "RDS/RBDS Group Hex Table"](#), on page 44.

Remote command:

n.a.

Select Group List

(enabled for data set Group List only)

Calls the "Load Group List" menu for group file selection.

Remote command:

`[:SOURce<hw>] :BB:STEReo:DS:DSET` on page 59

`[:SOURce<hw>] :BB:STEReo:DS:DSElect` on page 59

3.3 RDS/RBDS Groups Message Settings

The "RDS/RBDS Settings" menu allows you to configure the RDS/RBDS parameters. The RDS/RBDS parameters are divided into common RDS/RBDS settings and group type specific settings.

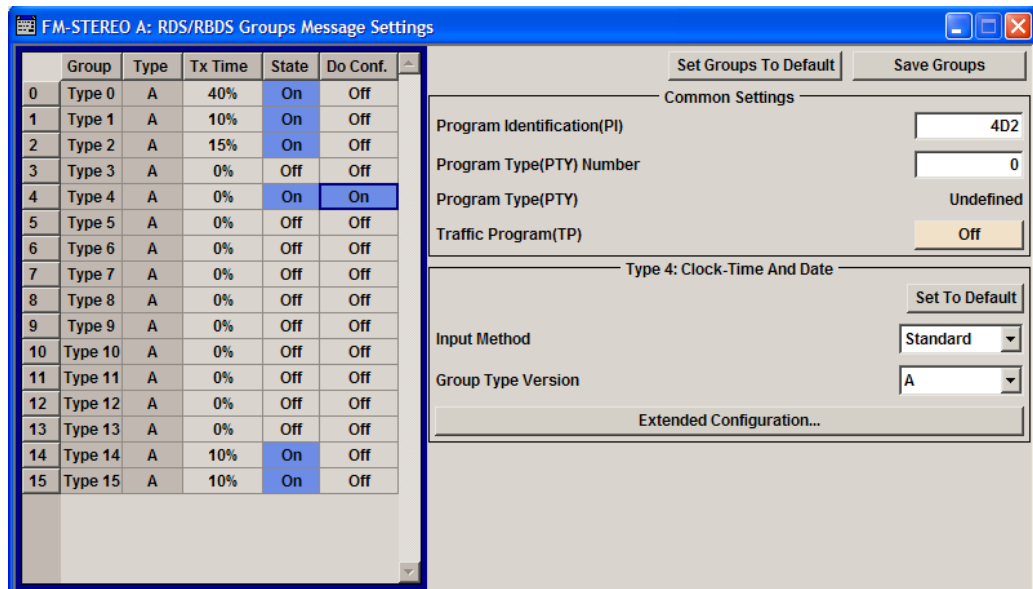

3.3.1 General Settings

Set Groups to Default

Sets all group parameter values to the default settings.

Remote command:

`[:SOURCE<hw>] :BB:STEREO:GRPS:PRESet` on page 83

Save Groups

Calls "Save Groups" menu for saving the settings to a file with extension *.fm_gt.

These files can be then loaded by means of the "Select Group List ..." button in the "RDS/RBDS Configuration" menu.

Remote command:

`[:SOURCE<hw>] :BB:STEREO:GRPS:STORE` on page 83

3.3.2 Common Settings

Program Identification (PI)

Sets the parameter PI (Program Identification) in hex format.

The PI code is an international network identifier. PI identifies the nation, the coverage area of the service and the radio network. PI can be used for automatically tuning and is transmitted in all the groups.

Remote command:

`[:SOURCE<hw>] :BB:STEREO:GRPS:CMNS:PI` on page 64

Program Type (PTY) Number

Sets the program type number (see [table 3-1](#)).

The PTY number identifies the content of the program.

PTY can be used for automatically tuning and is transmitted in all the groups.

Table 3-1: RDS/RBDS Program Types

PTY Code	RDS Program Type	RBDS Program Type
0	No program type or undefined	No program type or undefined
1	News	News
2	Current Affairs	Information
3	Information	Sports
4	Sports	Talk
5	Education	Rock
6	Drama	Classic Rock
7	Culture	Adult Hits
8	Science	Soft Rock
9	Varied	Top 40
10	Pop Music	Country
11	Rock Music	Oldies
12	M.O.R. Music	Soft
13	Light classical	Nostalgia
14	Serious classical	Jazz
15	Other Music	Classical
16	Weather	Rhythm and Blues
17	Finance	Soft Rhythm and Blues
18	Children's programs	Foreign Language
19	Social Affairs	Religious Music
20	Religion	Religious Talk
21	Phone In	Personality
22	Travel	Public
23	Leisure	College
24	Jazz Music	Unassigned
25	Country Music	Unassigned
26	National Music	Unassigned
27	Oldies Music	Unassigned
28	Folk Music	Unassigned

PTY Code	RDS Program Type	RBDS Program Type
29	Documentary	Weather
30	Alarm Test	Emergency Test
31	Alarm	Emergency Test

Remote command:

[:SOURce<hw>] :BB:STEReo:GRPS:CMNS:PTY on page 65

Program Type (PTY)

Displays the program type name of the selected PTY number (see [table 3-1](#)).

Remote command:

n.a.

Traffic Program (TP)

Enables/ disables the traffic program. TP code identifies radio programmes that continuously broadcasts traffic information.

TP can be used for automatically tuning and is transmitted in all the groups.

Remote command:

[:SOURce<hw>] :BB:STEReo:GRPS:CMNS:TP on page 65

3.3.3 Group Type 0A .. 15B Settings

The parameters in this section depend on the group type selected. To enable a group type for configuration, enable the corresponding parameter [Do Conf.](#) in the "Group Table".

The [table 3-2](#) gives an overview of the available RDS/RBDS Group Types.

Table 3-2: RDS/RBDS Group Type Codes

Group Type	Group Type Ver-sion	Description
0	A	Basic tuning and switching information only
	B	Basic tuning and switching information only
1	A	Program Item Number and slow labeling codes only
	B	Program Item Number
2	A	Radio text only
	B	Radio text only
3	A	Applications Identification for ODA only
	B	Open Data Applications
4	A	Clock-time and date only
	B	Open Data Applications
5	A	Transparent Data Channels (32 channels) or ODA

Group Type	Group Type Version	Description
	B	Transparent Data Channels (32 channels) or ODA
6	A	In House applications or ODA
	B	In House applications or ODA
7	A	Radio Paging or ODA
	B	Open Data Applications
8	A	Traffic Message Channel or ODA
	B	Open Data Applications
9	A	Emergency Warning System or ODA
	B	Open Data Applications
10	A	Program Type Name
	B	Open Data Applications
11	A	Open Data Applications
	B	Open Data Applications
12	A	Open Data Applications
	B	Open Data Applications
13	A	Enhanced Radio Paging or ODA
	B	Open Data Applications
14	A	Enhanced Other Networks information only
	B	Enhanced Other Networks information only
15	A	Defined in RBDS only
	B	Fast Basic Tuning and Switching Information

Table [table 2-1](#) gives an overview of the available frame formats per Group Type and Group Type Version. The frame format is displayed in the [RDS/RBDS User Message Table](#) dialog of the corresponding group type and group type version

Set to Default

Resets the RDS/RBDS Group specific settings.

Input Method

Selects the format the corresponding group type 0 ..15 will be represented for editing.

"Standard" Configuration based on direct parameter input

"User-defined" Allows configuration of the group type using a user-defined message

Remote command:

[:SOURCE<hw>] :BB:STEReo:GRPS:GT<st0>:INPMethod on page 69

Group Type Version

Selects A or B as group type version for the corresponding group type.

Remote command:

[:SOURCE<hw>] :BB:STEReo:GRPS:GT<st0>:VERsion on page 82

Text A/B Flag

(Enabled for "Group Type 2A/B" only)

Sets the Text A/B Flag to 0 (disabled parameter) or 1 (enabled parameter).

Each change of the state of the parameter Text A/B Flag (form 0 to 1 and from 1 to 0) triggers the receiver to clear the radio text and the program type name.

Remote command:

[:SOURCE<hw>] :BB:STEReo:GRPS:GT<st0>:TABFlag on page 79

Radio Text

(Enabled for "Group Type 2A" and "2B" only)

Sets the radio text.

The radio text is maximum 64 characters long for group type 2A and maximum 32 characters for group type 2B.

If less than 64 respectively 32 characters are used, the unused positions are filled in with zeros (0x00).

Remote command:

[:SOURCE<hw>] :BB:STEReo:GRPS:GT<st0>:RADText on page 77

A/B Flag

(Enabled for "Group Type 10A/B" only)

Sets the A/B Flag to 0 (disabled parameter) or 1 (enabled parameter).

Each change of the state of the parameter A/B Flag (form 0 to 1 and from 1 to 0) triggers the receiver to clear the radio text and the program type name.

Remote command:

[:SOURCE<hw>] :BB:STEReo:GRPS:GT<st0>:ABFLag on page 65

Program Type Name

(Enabled for "Group Type 10A" only)

Enters the program type name (max 8 characters).

If less than 8 characters are used, the unused positions are filled in with zeros (0x00).

Remote command:

[:SOURCE<hw>] :BB:STEReo:GRPS:GT<st0>:PTName on page 76

Extended Configuration .. - RDS/RBDS

(Enabled for "Input Method" set to "Parameters" only)

Calls the "Group 0/4A/14/15B Extended Configuration" menu for configuring the RDS/RBDS parameters.

The menus are described in [chapter 3.4, "Extended Configuration"](#), on page 31.

Remote command:

n.a.

Edit User Message Table .. - RDS/RBDS

(Enabled for "Input Method" set to "User Message Table" only)

Calls the "RDS/RBDS User Message Table - Group 0A .. 15B" menu for configuring the RDS/RBDS user message parameters in hex format. The checkwords are calculated automatically.

The menus are described in [chapter 3.5, "RDS/RBDS User Message Table - Group 0A .. 15B"](#), on page 43 .

Remote command:

n.a.

3.3.4 Group Table

The "Group Table" is located in the lower part of the menu.

Group

Displays the group type number.

Remote command:

n.a.

Type

Displays the group type version.

Remote command:

[\[:SOURCE<hw>\]:BB:STEReo:GRPS:GT<st0>:VERSion](#) on page 82

Tx Time

Sets the transmit time of the selected group. The transmit time is the group repetition rate given as proportion.

The sum of the transmit times of all groups can not exceed 100%. If the total transmit time is less than 100%, during the rest of the transmit time zeros will be transmitted.

Only groups with "State" set to On are transmitted.

Remote command:

[\[:SOURCE<hw>\]:BB:STEReo:GRPS:GT<st0>:TTIME](#) on page 80

State

Enables/disables the transmission of the corresponding group type.

Only groups with "State" set to On are transmitted.

Remote command:

[\[:SOURCE<hw>\]:BB:STEReo:GRPS:GT<st0>:STATE](#) on page 78

Do Conf

Enables/disables the corresponding group type for configuration. All editable parameters are displayed in the menu section "Group Type 0A .. 15B" (see [chapter 3.5, "RDS/RBDS User Message Table - Group 0A .. 15B"](#), on page 43).

To see the frame format of the selected group type, select "User-defined Input Method" and select "Edit User Message Table".

Remote command:

n . a .

3.4 Extended Configuration

The menu "Extended Configuration" is enabled only for group types 0A, 0B, 4A, 14A, 14B and 15B.

3.4.1 Group Type 0 - Extended Configuration

The menu is separated into two sections, "Group Type" Parameters and "Alternative Frequency List".

The List of the Alternative Frequencies contains a group of maximum 25 frequencies. The list comprises the frequencies of the station of the same network that broadcast the same radio program within the geographical area concerned.

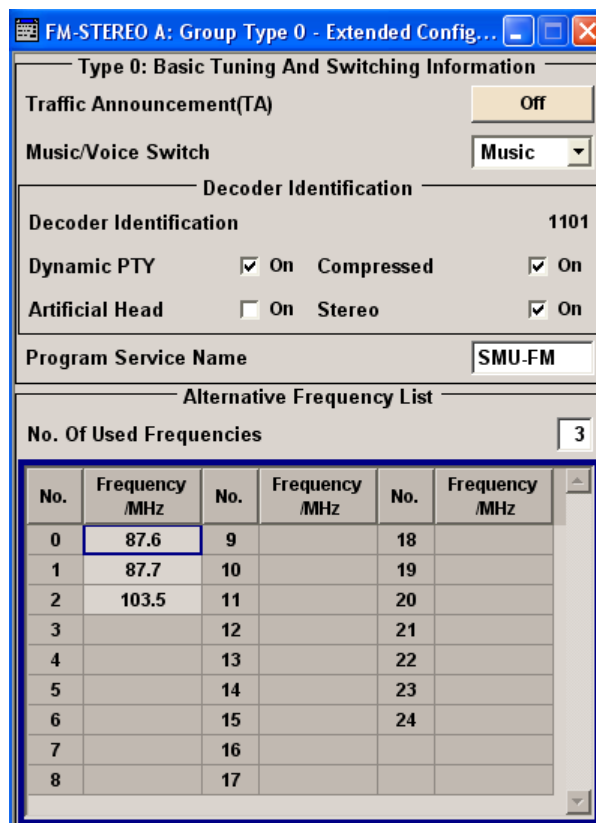

Traffic Announcement

Enables/disables broadcasting of traffic announcement. TA code indicates a traffic communication.

Remote command:

[:SOURce<hw>] :BB:STEReo:GRPS:GT<st0>:TA on page 79

Music/Voice Switch

Enables switching between speech and music transmission.

Remote command:

[:SOURce<hw>] :BB:STEReo:GRPS:GT<st0>:MVSWitch on page 73

Decoder Identification (DI)

Displays the decoder identification control code (DI) depending on the settings made for the parameter [Dynamic PTY](#), [Compressed](#), [Artificial Head](#) and [Stereo](#)

The DI is 4-bits long and identifies one of the 16 different operating modes of the decoder. The values of this 4 bits (d_0 , d_1 , d_2 and d_3) are set with the parameters "Stereo", "Artificial Head", "Compressed" and "Dynamic PTY" respectively.

Example:

```
SOUR:BB:STER:GRPS:GT0:DID:DPTY OFF
SOUR:BB:STER:GRPS:GT0:DID:COMP ON
SOUR:BB:STER:GRPS:GT0:DID:ARTH ON
SOUR:BB:STER:RDS:GT0:DID:STER OFF
SOUR:BB:STER:GRPS:GT0:DID:DATA?
Response: 0110
```

Remote command:

[:SOURce<hw>] :BB:STEReo:GRPS:GT<st0>:DID:DATA on page 68

Dynamic PTY - DI

Enables/disables dynamically PTY switching.

Disabled parameter corresponds to a static PTY and sets the d_3 bit of DI to 0; Dynamic PTY is indicated with 1.

Remote command:

[:SOURce<hw>] :BB:STEReo:GRPS:GT<st0>:DID:DPTY on page 69

Compressed - DI

Enables/disables the compressed bit of DI.

Disabled parameter sets the d_2 bit of DI to 0; enabled - to 1.

Remote command:

[:SOURce<hw>] :BB:STEReo:GRPS:GT<st0>:DID:COMPressed on page 68

Artificial Head - DI

Enables/disables using of Artificial Head.

Disabled parameter sets the d_1 bit of DI to 0; enabled - to 1.

Remote command:

[:SOURCE<hw>] :BB:STEReo:GRPS:GT<st0>:DID:ARTHead on page 68

Stereo - DI

Sets the mono/stereo switch in the DI.

Disabled parameter corresponds to Mono and sets the d_0 bit of DI to 0; Stereo is indicated with 1.

Remote command:

[:SOURCE<hw>] :BB:STEReo:GRPS:GT<st0>:DID:STEReo on page 69

Program Service Name

Enters the program service (PS) name. The PS name is displayed on the receiver and supply the listener with the name of the radio station.

PS cannot be used for automatic search.

The default maximum length of PS is 8 characters.

Remote command:

[:SOURCE<hw>] :BB:STEReo:GRPS:GT<st0>:PSName on page 75

No. Of Used Frequencies (Alternative Frequency List)

(Enabled for Group Type Version A only)

Sets the number of alternative frequency to be configured. A maximal number of 25 AFs can be configured.

Remote command:

[:SOURCE<hw>] :BB:STEReo:GRPS:GT<st0>:ALTF:NOENtries on page 67

Frequency/ MHz (Alternative Frequency List)

(Enabled for Group Type Version A only)

Sets the alternative frequency (AF) for the broadcast frequency.

The list(s) of alternative frequencies give information on the various transmitters broadcasting the same program in the same or adjacent reception areas, and enable receivers equipped with a memory to store the list(s), to reduce the time for switching to another transmitter.

Remote command:

[:SOURCE<hw>] :BB:STEReo:GRPS:GT<st0>:ALTF:DATA<ch0> on page 67

3.4.2 Group Type 4A - Extended Configuration

The Group Type 4 menu displays the clock time and date information.

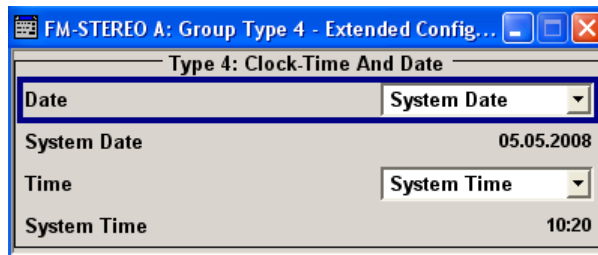
**Date**

Sets the date type to user date or system date.

Remote command:

`[:SOURCE<hw>] :BB:STEREO:GRPS:GT<st0>:DATE` on page 67

System Date

Displays the system date.

Remote command:

`[:SOURCE<hw>] :BB:STEREO:GRPS:GT<st0>:SYSDate` on page 78

User Date

Sets the user date in format DD.MM.YYYY.

Remote command:

`[:SOURCE<hw>] :BB:STEREO:GRPS:GT<st0>:USRDate` on page 81

Time

Sets the time type to system time or user time.

Remote command:

`[:SOURCE<hw>] :BB:STEREO:GRPS:GT<st0>:TIME` on page 80

System Time

Displays the system time.

Remote command:

`[:SOURCE<hw>] :BB:STEREO:GRPS:GT<st0>:SYSTime` on page 78

User Time

Sets the user time in format HH:MM.

Remote command:

`[:SOURCE<hw>] :BB:STEREO:GRPS:GT<st0>:USRTime` on page 82

Local Offset Time

(available for "User Time" only)

Sets the local offset time expressed in multiples of half hours within the range -12h to +12h.

The time is the sum of the user time and the local time offset.

Remote command:

`[:SOURCE<hw>] :BB:STEREO:GRPS:GT<st0>:LOTime` on page 71

3.4.3 Group Type 14 - Extended Configuration

The menu is separated into two sections, one section that is always displayed, "Group Type" Parameters, and a dynamic one, where the parameters displayed depend on the selection made for the parameter [Information Block](#).

The Group Type 14 has two versions: A and B. The A version is the normal form and shall be used for the background transmission of Enhanced Other Networks information. The B version of a type 14 group is used to indicate a change in the status of the TA flag of a cross-referenced program service.

The Group Type 14 Version A has 16 variants which can be used in any time mixture and order. Variant 4 (AF method A) and variants 5 to 9 (Mapped Frequency Method) are defined for the transmission of frequencies of cross-referenced program services.

The [figure 3-1](#) shows the frame format of group type 14 version A, according to the RDS/RBDS standard.

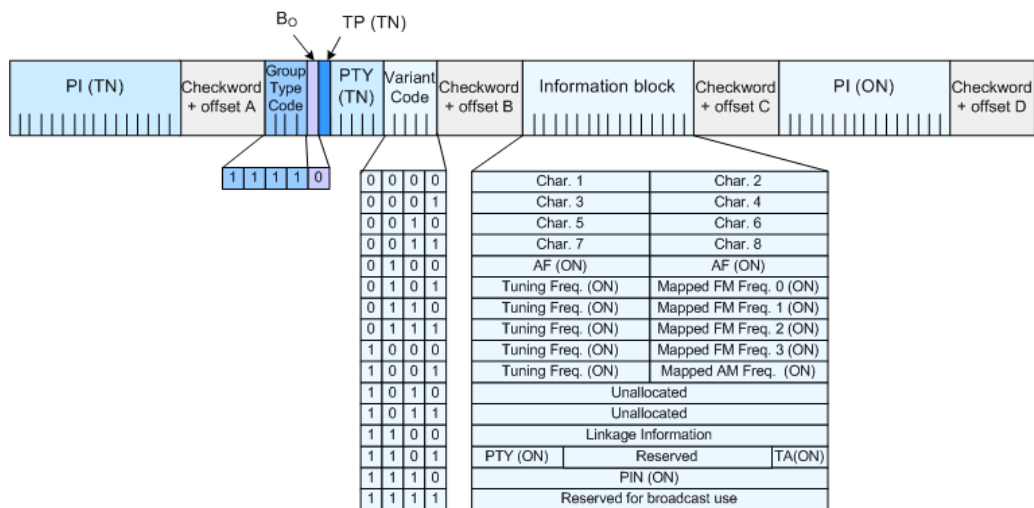

Fig. 3-1: Frame format of group type 14A

Switching between the different variants is performed with the parameter "Information Block".

The [table 3-3](#) gives an overview of the cross-reference between the Group Type 14A variants and the content of the Information Block.

Table 3-3: Information Block Content (Group Type 14A)

Group Type 14A Variant	Information Block
0...3	PS (ON)
4	AF (ON)
5...8	Mapping between Tuning Freq. (TN) and Mapped FM Freq. 0 .. 3 (ON)
9	Mapping between Tuning Freq. (TN) and the Mapped AM Freq. (ON)
10...11	Unallocated

Group Type 14A Variant	Information Block
12	Linkage Information
13	PTY (ON), 10 Reserved Bits, TA (ON)
14	PIN (ON)
15	Reserved for Broadcast use

3.4.3.1 Alternative Frequencies

Alternative Frequencies are set in the Alternative Frequency List. Method AF method A is configured with the parameters "Frequency (ON)". The List of the Alternative Frequencies contains a group of maximum 25 frequencies. The list comprises the frequencies of the stations of the other networks that broadcast the same radio program.

3.4.3.2 Mapped Frequencies

Mapped Frequencies are set in the Mapped Frequency List. The "Mapped Frequency List" sets the cross-reference between the frequency in the tuned network ([Tuning Frequency \(TN\)/ MHz](#)) and the corresponding one or more frequencies in other network. The table allows a mapping to more than one VHF/FM frequency ([Mapped Frequency \(ON\) 0 .. 3](#)) and to one LF/MF frequency (Mapped Frequency (ON) 4).

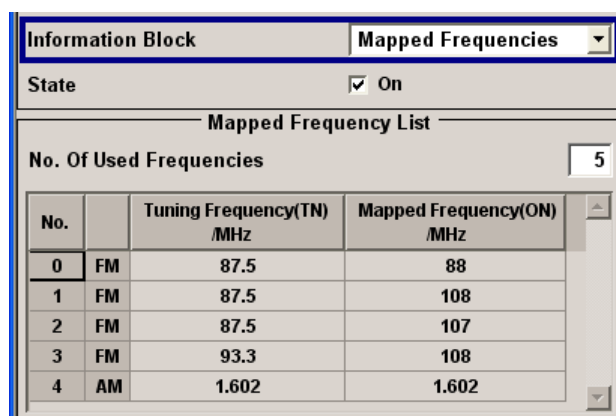
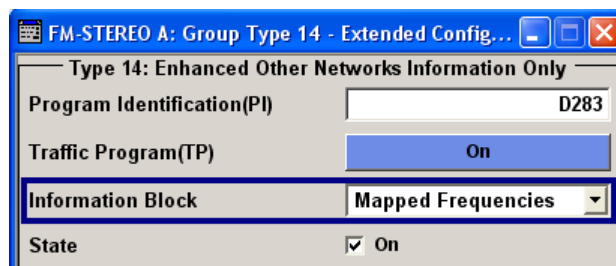

Program Identification (PI) - Other Networks (ON)

Sets the parameter Program Identification of other networks in hex format.

The PI code is an international network identifier. PI identifies the nation, the coverage area of the service and the radio network. PI can be used for automatically tuning and is transmitted in all the groups.

Remote command:

[:SOURce<hw>] :BB:STEReo:GRPS:GT<st0>:PION on page 75

Traffic Program (TP) - Other Networks (ON)

Enables/ disables the traffic program of other networks. TP code identifies radio programmes that continuously broadcasts traffic information.

Remote command:

[:SOURce<hw>] :BB:STEReo:GRPS:GT<st0>:TPON on page 80

Information Block

(Enabled for group type version A only)

Sets the Group Type 14A variant codes. Depending on the selection made for this parameter; different additional parameters are displayed for configuration.

"Program Service"

Sets the content of Information Block Variant Codes 0..3 - PS (ON).

"AF"

Sets the content of Information Block Variant Code 4 - Alternative Frequencies Method A.

Alternative Frequency List					
No. Of Used Frequencies					
No.	Frequency /MHz	No.	Frequency /MHz	No.	Frequency /MHz
0	87.6	9		18	
1	87.7	10		19	
2	107.5	11		20	
3	99.4	12		21	
4		13		22	

"Mapped Frequency"

Sets the content of Information Block Variant Codes 5..9 - Mapped Frequencies.

Information Block		Mapped Frequencies	
State		<input checked="" type="checkbox"/> On	
Mapped Frequency List			
No. Of Used Frequencies			5
No.		Tuning Frequency(TN) /MHz	Mapped Frequency(ON) /MHz
0	FM	87.5	88
1	FM	87.5	108
2	FM	87.5	107
3	FM	93.3	108
4	AM	1.602	1.602

"Linkage Information"

Sets the content of Information Block Variant Code 12 - Linkage Information.

Information Block		Linking Information	
State		<input checked="" type="checkbox"/> On	
Linkage Actuator(LA)		On	
Extended Generic Indicator(EG)		On	
International Linkage Set Ind.		On	
Linkage Set Number(LSN)		101	

"PTY/TA"

Sets the content of Information Block Variant Code 13 - PTY (ON) and TA (ON).

Information Block		PTY/TA	
State		<input checked="" type="checkbox"/> On	
Program Type(PTY) Number		3	
Program Type(PTY)		Information	
Traffic Announcement(TA)		On	

"PIN"

Sets the content of Information Block Variant Code 14 - PIN (ON).

Information Block		PIN	
State		<input checked="" type="checkbox"/> On	
Program Item Number		1F3B	

Remote command:

n . a .

State (Program Service) - Other Networks (ON)

(Enabled for group type version A and Information Block set to Program Service only)

Enables/disables sending of program service name of other networks PS (ON).

Remote command:

[:SOURce<hw>] :BB:STEReo:GRPS:GT<st0>:PSON:STATe on page 76

Program Service (PS) Name - Other Networks (ON)

(Enabled for group type version A and Information Block set to Program Service only)

Enters the program service name of other networks.

The PS name has a length of max 8 characters. If less than 8 characters are used, the unused positions are filled in with zeros (0x00).

Remote command:

[:SOURce<hw>] :BB:STEReo:GRPS:GT<st0>:PSON:PSName on page 75

State (Alternative Frequency)

(Enabled for group type version A and Information Block set to AF only)

Enables/disables using AF method A.

Remote command:

[:SOURce<hw>] :BB:STEReo:GRPS:GT<st0>:AFON:STATe on page 66

No. Of Used Frequencies (Alternative Frequency List ON)

(Enabled for Group Type Version A only)

Sets the number of alternative frequency of other networks to be configured. A maximal number of 25 AFs can be configured.

Remote command:

[:SOURce<hw>] :BB:STEReo:GRPS:GT<st0>:AFON:NOENtries on page 66

Frequency/ MHz (Alternative Frequency List ON)

(Enabled for Group Type Version A only)

Sets the alternative frequency (AF) of other networks for the broadcast frequency.

The list(s) of alternative frequencies give information on the various transmitters of other networks broadcasting the same program in the same or adjacent reception areas, and enable receivers equipped with a memory to store the list(s), to reduce the time for switching to another transmitter.

Remote command:

[:SOURce<hw>] :BB:STEReo:GRPS:GT<st0>:AFON:DATA<ch0> on page 65

State (Mapped Frequencies)

(Enabled for group type version A and Information Block set to Mapped Frequencies only)

Enables/disables using of mapped frequencies.

Remote command:

[:SOURce<hw>] :BB:STEReo:GRPS:GT<st0>:MFL:STATe on page 73

No. Of Used Frequencies (Mapped Frequency List)

(Enabled for group type version A and Information Block set to Mapped Frequencies only)

Sets the number of mapped frequency to be configured. A maximal number of 5 frequencies can be configured.

The mapped frequencies are the frequencies of other network that are cross-referenced to the frequencies in the tuned network to allow a transmission of several different services from the same transmitter with the same coverage area.

Remote command:

`[:SOURCE<hw>] :BB:STEReo:GRPS:GT<st0>:MFL:NOENtries` on page 73

Radio Band (Mapped Frequency List)

(Enabled for group type version A and Information Block set to Mapped Frequencies only)

Displays the radio band, AM or FM, used.

The first four frequencies (Frequency 0 .. 3) are VHF/FM frequencies (FM); the last one (Frequency 4) is a LF/MF frequency (AM).

Remote command:

n.a.

Tuning Frequency (TN)/ MHz

(Enabled for group type version A and Information Block set to Mapped Frequencies only)

Sets the tuning frequency.

Remote command:

`[:SOURCE<hw>] :BB:STEReo:GRPS:GT<st0>:MFL:DATA<ch0>:TF` on page 72

Mapped Frequency (ON)/ MHz

(Enabled for group type version A and Information Block set to Mapped Frequencies only)

Sets the FM/AM frequency.

Selected FM/AM frequency is mapped to the tuned frequency.

Remote command:

`[:SOURCE<hw>] :BB:STEReo:GRPS:GT<st0>:MFL:DATA<ch0>:MF` on page 72

State (Linkage Information)

(Enabled for group type version A and Information Block set to Linkage Information)

Enables/disables using of Linkage Information (ON).

Linkage Information enables the receiver to treat several program services as a single service.

Remote command:

`[:SOURCE<hw>] :BB:STEReo:GRPS:GT<st0>:LION:STATe` on page 71

Linkage Actuator (LA)

(Enabled for group type version A and Information Block set to Linkage Information)

Enables/disables the Linkage Actuator LA for other networks.

Enabled LA corresponds to active link (LA=1), i.e. the program service is linked to the set of services, set with the [Linkage Set Number \(LSN\)](#).

Disabled LA corresponds to passive link (LA=0), i.e. the link is currently not active but becomes active in the future.

Remote command:

[:SOURCE<hw>] :BB:STEReo:GRPS:GT<st0>:LION:LA on page 70

Extended Generic Indicator (EG)

(Enabled for group type version A and Information Block set to Linkage Information)

Enables/disables the Extended Generic Indicator EG for other networks.

Enabled EG corresponds to EG=1, i.e. the program service is a member of an extended generic set.

Remote command:

[:SOURCE<hw>] :BB:STEReo:GRPS:GT<st0>:LION:EG on page 69

International Linkage Set Ind.

(Enabled for group type version A and Information Block set to Linkage Information)

Enables/disables the International Linkage Set indicator ILS for other networks.

Enabled ILS corresponds to international link (ILS=1).

Remote command:

[:SOURCE<hw>] :BB:STEReo:GRPS:GT<st0>:LION:ILS on page 70

Linkage Set Number (LSN)

(Enabled for group type version A and Information Block set to Linkage Information)

Sets the Linkage Set Number LSN for other networks.

The LSN is a 12 bit number.

Remote command:

[:SOURCE<hw>] :BB:STEReo:GRPS:GT<st0>:LION:LSN on page 70

State (PTY/TA) - Other Networks (ON)

(Enabled for group type version A and Information Block set to PTY/TA)

Enables/disables using of PTY (ON) and TA (ON).

Remote command:

[:SOURCE<hw>] :BB:STEReo:GRPS:GT<st0>:PTYTa:STATE on page 77

Program Type (PTY) Number - Other Networks (ON)

(Enabled for group type version A and Information Block set to PTY/TA)

Sets the program type number of other networks (see [table 3-1](#)).

Remote command:

[:SOURCE<hw>] :BB:STEReo:GRPS:GT<st0>:PTYTa:PTY on page 76

Traffic Announcement (TA) - Other Networks (ON)

Enables/disables the traffic announcement (TA) of other networks. TA code indicates a traffic communication.

Remote command:

[:SOURce<hw>] :BB:STEReo:GRPS:GT<st0>:TAON on page 79

State (PIN) - Other Networks (ON)

(Enabled for group type version A and Information Block set to PIN)

Enables/disables using of PIN (ON).

Remote command:

[:SOURce<hw>] :BB:STEReo:GRPS:GT<st0>:PINon:STATe on page 74

Program Item Number (PIN) - Other Networks (ON)

(Enabled for group type version A and Information Block set to PIN)

Enters the program item number (PIN) of other networks.

The transmitted Program Item Number code is the scheduled broadcast start time and day of month as published by the broadcaster.

Remote command:

[:SOURce<hw>] :BB:STEReo:GRPS:GT<st0>:PINon:PIN on page 74

3.4.4 Group Type 15 - Extended Configuration

The Group Type 15 menu displays the basic tuning and switching information, as selected for group type 0.

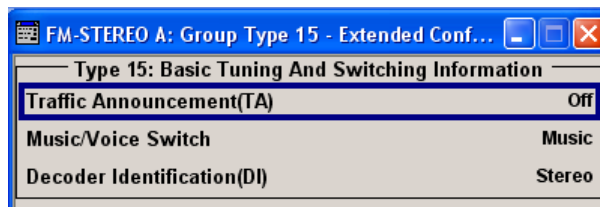
**Traffic Announcement**

Enables/disables broadcasting of traffic announcement. TA code indicates a traffic communication.

Remote command:

[:SOURce<hw>] :BB:STEReo:GRPS:GT<st0>:TA on page 79

Music/Voice Switch

Enables switching between speech and music transmission.

Remote command:

[:SOURce<hw>] :BB:STEReo:GRPS:GT<st0>:MVSWith on page 73

Decoder Identification (DI)

(enabled for group type version B only)

Displays the current decoder operating mode (mono, stereo, rtc.) as selected for group type 0.

Remote command:

[:SOURCE<hw>] :BB:STEReo:GRPS:GT<st0>:DID:DATA on page 68

3.5 RDS/RBDS User Message Table - Group 0A .. 15B

The "RDS/RBDS User Message" table allows direct configuration of the user message in hex format (see also chapter 2.2, "Baseband Coding and Group Structure", on page 10).

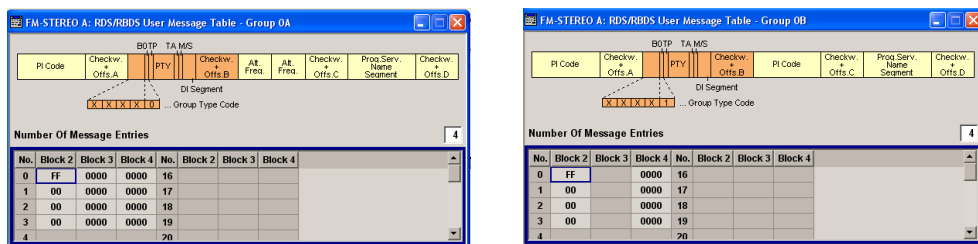

Depending on the selected "Group Type" and "Group Type Version", the frame format is displayed.

No. Of Message Entries (User Message Table)

Sets the number of transmitted groups per message. A maximal number of 32 groups can be configured.

Remote command:

[:SOURCE<hw>] :BB:STEReo:GRPS:GT<st0>:UMT:NOENTries on page 81

Block 2 (User Message Table)

Sets the hex value for Block 2 of the corresponding user message hex table row.

Checkword and offset B are automatically calculated.

Remote command:

[:SOURCE<hw>] :BB:STEReo:GRPS:GT<st0>:UMT:DATA<ch0>:BLOCK<user> on page 81

Block 3 (User Message Table)

(enabled for group type version A only)

Sets the hex value for Block 3 of the corresponding user message hex table row.

Checkword and offset C are automatically calculated.

Remote command:

[:SOURCE<hw>] :BB:STEReo:GRPS:GT<st0>:UMT:DATA<ch0>:BLOCK<user> on page 81

Block 4 (User Message Table)

(enabled for group type version A only)

Sets the hex value for Block 4 of the corresponding user message hex table row.
 Checkword and offset D are automatically calculated.

Remote command:

`[:SOURCE<hw>] :BB:STEReo:GRPS:GT<st0>:UMT:DATA<ch0>:BLOCK<user>`

on page 81

3.6 RDS/RBDS Group Hex Table

Alternatively to selecting RDS/RBDS Parameters, the RDS/RBDS Message Blocks can be directly configured in hex format.

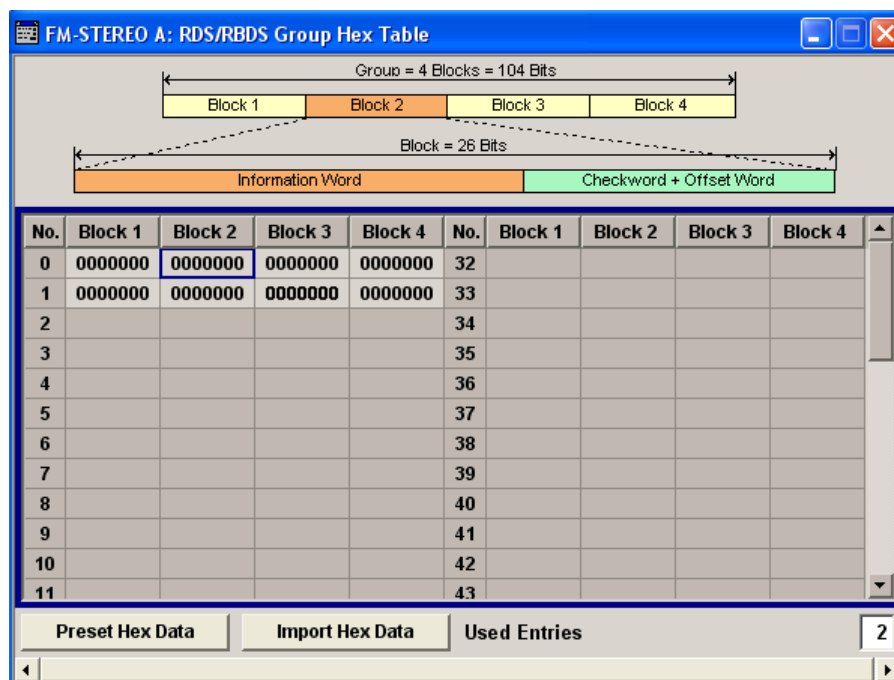

No.

Displays the group hex table row number.

Block 1 .. 4 (Group Hex Table)

Sets the hex value for the Block 1 .. 4 of the corresponding group hex table row.

Remote command:

`[:SOURCE<hw>] :BB:STEReo:GHEx:DATA<ch0>:BLOCK<st>` on page 62

Preset Hex Table

Presets the group hex table.

Remote command:

`[:SOURCE<hw>] :BB:STEReo:GHEx:PRESet` on page 62

Load Hex Data

Opens the "Load Group Hex Data" dialog for loading of group lists files in hex format. The hex file is generated externally and has to have an extension *.fm_ghex.

A group list file in hex format are file with extension *.fm_ghex and the following format:

Parameter	Description
GroupTypeXXX	Group Type and Group Type Version, where XXX=00A, 00B, .. 15A, 15B
:	Separator between the Group Type and the Data Blocks
0xNNNNNNNN	where: 0x indicates the data format (hex format) and NNNNNNNN is the 26-bit long data per Block, i.e. the Information Word and the Checkword + Offset Word.
,	Separator between the Data Blocks
//	Comment separator

The figure below gives an example of group list file in hex format.

```
// Type      Block 1   Block 2   Block 3   Block 4
// -----
GroupType00A: 0x0123456, 0x1234567, 0x2345678, 0x3456789 // Comment
GroupType00B: 0x0123456, 0x1234567, 0x2345678, 0x3456789 // Comment
GroupType00A: 0x0123456, 0x1234567, 0x2345678, 0x3456789 // Comment
GroupType00A: 0x0123456, 0x1234567, 0x2345678, 0x3456789 // Comment
GroupType00A: 0x0123456, 0x1234567, 0x2345678, 0x3456789 // Comment
GroupType10A: 0x0123456, 0x1234567, 0x2345678, 0x3456789 // Comment
GroupType11A: 0x0123456, 0x1234567, 0x2345678, 0x3456789 // Comment
GroupType12A: 0x0123456, 0x1234567, 0x2345678, 0x3456789 // Comment
GroupType13A: 0x0123456, 0x1234567, 0x2345678, 0x3456789 // Comment
```

Remote command:

```
[ :SOURCE<hw> ] :BB:STEReo:GHEX:LOAD on page 62
```

Used Entries

Sets the number of messages to be configured. A maximal number of 64 messages can be configured.

Remote command:

```
[ :SOURCE<hw> ] :BB:STEReo:GHEX:NOENTries on page 62
```

3.7 Trigger

To access this dialog, select "Main Menu > Trigger/Marker".

The "Trigger In" section is where the trigger for the signal is set. The current status of signal generation ("Running" or "Stopped") is indicated.

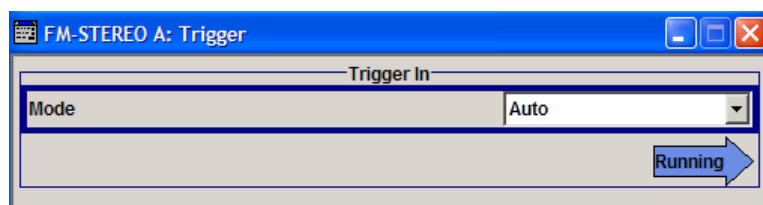

The buttons in the last section lead to submenu for general trigger, clock and mapping settings.

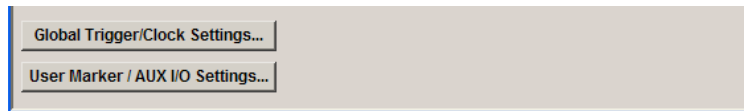

3.7.1 Trigger In

The "Trigger In" section is where the trigger for the signal is set.

The current status of signal generation ("Running" or "Stopped") is indicated for all trigger modes.

Trigger Mode

Selects trigger mode.

The trigger mode determines the effect of a trigger on the signal generation.

"Auto" The signal is generated continuously.

Remote command:

[\[:SOURCE<hw>\]:BB:STEReo\[:TRIGger\]:SEQuence](#) on page 58

Running/Stopped

Displays the status of signal generation for all trigger modes. This display appears only when signal generation is enabled ("State" On).

"Running" The modulation signal is generated; a trigger was (internally or externally) initiated in triggered mode.

"Stopped" The signal is not generated, and the instrument waits for a trigger event (internal or external).

Remote command:

[\[:SOURCE<hw>\]:BB:STEReo:TRIGger:RMODe](#) on page 57

3.7.2 Global Settings

The buttons in this section lead to dialogs for general trigger, clock and mapping settings.

Global Trigger/Clock Settings

Calls the "Global Trigger/Clock/Input Settings" dialog.

This dialog is used among other things for setting the trigger threshold, the input impedance and the polarity of the clock and trigger inputs.

The parameters in this dialog affect all digital modulations and standards, and are described in chapter "Global Trigger/Clock/Input Settings" in the Operating Manual.

User Marker / AUX I/O Settings

Calls the "User Marker AUX I/O Settings" dialog, used to map the connector on the rear of the instruments.

See also "User Marker / AUX I/O Settings" in the Operating Manual.

4 Remote-Control Commands

The following commands are required to perform signal generation with the FM-Stereo/RDS options in a remote environment. We assume that the R&S Signal Generator has already been set up for remote operation in a network as described in the R&S Signal Generator documentation. A knowledge about the remote control operation and the SCPI command syntax are assumed.



Conventions used in SCPI command descriptions

For a description of the conventions used in the remote command descriptions, see section "Remote Control Commands" in the R&S Signal Generator operating manual.

Common Suffixes

The following common suffixes are used in remote commands:

Suffix	Value range	Description
SOURce<hw>	[1] 2	available baseband signals
OUTPut<ch>	1 .. 4	available markers R&S SMBV supports two markers
EXTernal<ch>	1 2	external trigger connectors

Placeholder <root>

For commands that read out or save files in the default directory, the default directory is set using command `MMEM:CDIRECTory`. The examples in this description use the place holder `<root>` in the syntax of the command.

- `D:\` - for selecting the internal hard disk of a Windows instrument
- `E:\` - for selecting the memory stick which is inserted at the USB interface of a Windows instrument
- `/var/user/` - for selecting the internal flash card of a Linux instrument
- `/usb/` - for selecting the memory stick which is inserted at the USB interface of a Linux instrument.



Tasks (in manual or remote operation) that are also performed in the base unit in the same way are not described here.

In particular, this includes:

- Managing settings and data lists, i.e. storing and loading settings, creating and accessing data lists, accessing files in a particular directory, etc.
- Information on regular trigger, marker and clock signals as well as filter settings, if appropriate.
- General instrument configuration, such as configuring networks and remote operation
- Using the common status registers

For a description of such tasks, see the R&S Signal Generator operating manual.

The following commands specific to the `SOURce:BB:STEReo` subsystem are described here:

4.1 Primary Commands

<code>[:SOURce<hw>]:BB:STEReo:STATe</code>	50
<code>[:SOURce<hw>]:BB:STEReo:PRESet</code>	51
<code>[:SOURce<hw>]:BB:STEReo:SETTing:CATalog?</code>	51
<code>[:SOURce<hw>]:BB:STEReo:SETTing:LOAD</code>	51
<code>[:SOURce<hw>]:BB:STEReo:SETTing:STORE</code>	52
<code>[:SOURce<hw>]:BB:STEReo:SETTing:STORE:FAST</code>	52
<code>[:SOURce<hw>]:BB:STEReo:DEVIation</code>	52
<code>[:SOURce<hw>]:BB:STEReo:SOURce</code>	53
<code>[:SOURce<hw>]:BB:STEReo:AUDio:CATalog?</code>	53
<code>[:SOURce<hw>]:BB:STEReo:AUDio:DSElect</code>	54
<code>[:SOURce<hw>]:BB:STEReo:AUDio:EXTClock</code>	54
<code>[:SOURce<hw>]:BB:STEReo:AUDio:LEVel</code>	54
<code>[:SOURce<hw>]:BB:STEReo:AUDio:MODE</code>	55
<code>[:SOURce<hw>]:BB:STEReo:AUDio:PREemphasis</code>	55
<code>[:SOURce<hw>]:BB:STEReo:AUDio[:FREQuency]</code>	56
<code>[:SOURce<hw>]:BB:STEReo:PILot:PHASe</code>	56
<code>[:SOURce<hw>]:BB:STEReo:PILot:STATe</code>	56
<code>[:SOURce<hw>]:BB:STEReo:PILot[:DEVIation]</code>	56
<code>[:SOURce<hw>]:BB:STEReo:PUWSint</code>	57
<code>[:SOURce<hw>]:BB:STEReo:TRIGger:RMODE</code>	57
<code>[:SOURce<hw>]:BB:STEReo[:TRIGger]:SEQUence</code>	58

`[:SOURce<hw>]:BB:STEReo:STATe <State>`

Activates the standard and deactivates all the other digital standards and digital modulation modes in the same path.

Parameters:

<State> 0 | 1 | OFF | ON
 *RST: 0

Example: SOURCE1:BB:STEREO:STATE ON

Manual operation: See "State" on page 16

[:SOURCE<hw>]:BB:STEREO:PRESet

Sets the parameters of the digital standard to their default values (*RST values specified for the commands).

Not affected is the state set with the command SOURCE<hw>:BB:STEREO:STATE

Example: SOURCE1:BB:STEREO:PRESet

Usage: Event

Manual operation: See "Set To Default" on page 16

[:SOURCE<hw>]:BB:STEREO:SETTING:CATalog?

Reads out the files with FM-STEREO settings in the default directory.

The directory is set using command MMEM:CDIRECTORY. A path can also be specified, in which case the files in the specified directory are read. The file extension may be omitted. Only files with the file extension *.fm will be listed.

Return values:

<Catalog> string

Example: MMEM:CDIR '<root>FMSTereo'
 sets the default directory
 SOUR:BB:STER:SETT:CAT?
 reads out all the files with FM Stereo settings in the default directory
 Response: fm_stereo1, fm_stereo 2

Usage: Query only

Manual operation: See "Save/Recall.." on page 16

[:SOURCE<hw>]:BB:STEREO:SETTING:LOAD <Load>

Loads the selected file with FM Stereo settings.

The directory is set using command MMEM:CDIRECTORY. A path can also be specified, in which case the files in the specified directory are read. The file extension may be omitted. Only files with the file extension *.fm will be loaded.

Setting parameters:

<Load> string

Example: `SOUR:BB:STER:SETT:LOAD 'fm_configuration1'`
loads the file `fm_configuration1.fm`

Usage: Setting only

Manual operation: See "[Save/Recall.](#)" on page 16

[[:SOURce<hw>]:BB:STEReo:SETTING:STORe <Store>

Stores the selected file with FM-STEREO settings.

The directory is set using command `MMEM:CDIRectory`. A path can also be specified, in which case the files in the specified directory are read. The file extension may be omitted. FM-STEREO settings are stored as files with the specific file extension `*.fm`.

Setting parameters:

<Store> string

Example: `SOUR:BB:STER:SETT:STOR 'fm_configuration1'`
stores the current setting

Usage: Setting only

Manual operation: See "[Save/Recall.](#)" on page 16

[[:SOURce<hw>]:BB:STEReo:SETTING:STORe:FAST <Fast>

Determines whether the instrument performs an absolute or a differential storing of the settings.

Enable this function to accelerate the saving process by saving only the settings with values different to the default ones.

Note: This function is not affected by the "Preset" function.

Parameters:

<Fast> 0 | 1 | OFF | ON
*RST: 0

[[:SOURce<hw>]:BB:STEReo:DEViation <Deviation>

Sets the frequency deviation of the stereo signal.

Parameters:

<Deviation> integer
Range: 0 to 80000
Increment: 10
*RST: 67500

Example: `SOURce:BB:STER:DEV 70000`
sets the deviation value 70kHz

Manual operation: See "[Deviation](#)" on page 17

[:SOURce<hw>]:BB:STEReo:SOURce <Source>

Selects the audio source for the FM-Stereo signal.

The sources cannot be used simultaneously.

Parameters:

<Source>

OFF | SPEXt | LFGen | FILE

OFF

The audio source is switched off.

SPEXt

Activates the S/P-DIF input for the external digital modulation signals.

for R&S SMU/SMJ/SMATE and R&S AMU instruments:

The audio source for path A/B has to be connected respectively to the USER1/2 connector on the rear panel.

for R&S SMBV instrument:

The audio source has to be connected to the MARKER connector on the rear panel.

Note: In case an audio signal is applied to the S/P-DIF interface, an "Extern Clock Source" has to be selected and the parameter "Threshold Trigger/Control Input" has to be set to 0,01 V.

LFGen

The audio source is generated by the internal LF generator.

The frequency of the LF generator is set with the command [:SOURce<hw>]:BB:STEReo:AUDio [:FREQuency].

FILE

A WAV-File can be selected. Audio files are selected with the command [:SOURce<hw>]:BB:STEReo:AUDio:DSElect

*RST: 0

Example:

SOUR:BB:STER:SOUR LFG

selects the audio source

SOUR:BB:STER:AUD:FREQ 1000

sets the LF Generator Frequency

Manual operation: See "Audio Source" on page 17

[:SOURce<hw>]:BB:STEReo:AUDio:CATalog?

Reads out the Waveform files in the default directory.

The directory is set using command `MMEM:CDIRectory`. A path can also be specified, in which case the files in the specified directory are read. The file extension may be omitted. Only files with the file extension `*.wav` will be listed.

Return values:

<Catalog>

string

Example: MMEM:CDIR '<root>FMStereo'
sets the default directory
SOUR:BB:STER:AUD:CAT?
reads out all the waveform files in the default directory
Response: fm_stereo_waveform1,
fm_stereo_waveform2

Usage: Query only

[:SOURce<hw>]:BB:STEReo:AUDio:DSElect <DSelect>

Loads the selected file with audio data. The file extension may be omitted. Only files with the file extension *.wav will be loaded.

Setting parameters:

<DSelect> string

Example: SOUR:BB:STER:SOUR FILE
selects the audio source
MMEM:CDIR '<root>waveforms'
sets the default directory
SOUR:BB:STER:AUD:DSEL 'fm_wave'
loads the audio file fm_wave.wav from the default directory

Usage: Setting only

Manual operation: See "[Load Audio File](#)" on page 20

[:SOURce<hw>]:BB:STEReo:AUDio:EXTClock <ExtClock>

Sets the external clock (44.1 or 48 kHz) in case an external S/P-DIF audio source is selected.

Parameters:

<ExtClock> 44100 | 48000
*RST: 44100

Example: SOUR:BB:STER:SOUR SPEX
selects the audio source
SOUR:BB:STER:AUD:EXTC 48000
sets the external clock to 48 kHz

Manual operation: See "[External Clock](#)" on page 20

[:SOURce<hw>]:BB:STEReo:AUDio:LEVel <Level>

Sets the level of the audio signal.

Parameters:

<Level> float
 Range: -30 to 10
 Increment: 0.01
 *RST: 0
 Default unit: dBfs

Example:

SOUR:BB:STER:AUD:LEV -10.00
 sets the audio level -10dBfs

Manual operation: See "Audio Level" on page 21

[:SOURce<hw>]:BB:STEReo:AUDio:MODE <Mode>

Selects the operating mode.

Parameters:

<Mode> LEFT | RIGHT | RELeft | REMLeft | RNELeft
LEFT
 Audio signal only in the left-hand channel
RIGHT
 Audio signal only in the left-hand channel
RELeft
 Audio signals of the same frequency and phase in both channels
REMLeft
 Audio signals of same frequency but opposite phase in both channels
RNELeft
 Different and independent audio signals in both channels (not possible with source selection LF Generator)
 *RST: RNELeft

Example:

SOUR:BB:STER:AUDio:MODE RNEL
 sets the audio mode to true stereo

Manual operation: See "Audio Mode" on page 20

[:SOURce<hw>]:BB:STEReo:AUDio:PREemphasis <PreEmphasis>

Enables/disables and sets the preemphasis parameter value to 50us or 75us.

Parameters:

<PreEmphasis> OFF | 50 | 75
 *RST: OFF

Example:

SOUR:BB:STER:AUD:PRE 50
 sets the preemphasis to 50 us

Manual operation: See "Preemphasis" on page 21

[[:SOURce<hw>]:BB:STEReo:AUDio[:FREQUency] <Frequency>

Sets the frequency of the LF-Generator in case a LF-Generator is selected as audio source.

Parameters:

<Frequency> float
 Range: 20 to 15000
 Increment: 0.01
 *RST: 1000

Example:

SOUR:BB:STER:SOUR LFG
 selects the audio source
 SOUR:BB:STER:AUD:FREQ 1000
 sets the LF Generator Frequency to 1 kHz

Manual operation: See "[LF Generator Frequency](#)" on page 20

[[:SOURce<hw>]:BB:STEReo:PILot:PHASe <Phase>

Sets the phase of the pilot tone (with respect to the 38 kHz subcarrier). The parameter is enabled only for enabled pilot tone.

Parameters:

<Phase> float
 Range: -50 to 50
 Increment: 0.1
 *RST: 0

Example:

SOUR:BB:STER:PIL:PHAS -3
 sets the phase to 3 degrees

Manual operation: See "[Pilot Phase](#)" on page 21

[[:SOURce<hw>]:BB:STEReo:PILot:STATe <State>

Enables/disables the pilot tone.

Stereo operating mode is possible with enabled pilot tone only.

Parameters:

<State> 0 | 1 | OFF | ON
 *RST: ON

Example:

SOUR:BB:STER:PIL:STAT ON
 enables pilot tone

Manual operation: See "[Pilot State](#)" on page 21

[[:SOURce<hw>]:BB:STEReo:PILot[:DEViation] <Deviation>

Sets the frequency deviation of the pilot tone. The parameter is enabled only for enabled pilot tone.

Parameters:

<Deviation> integer
 Range: 0 to 10000
 Increment: 10
 *RST: 6750

Example:

SOUR:BB:PIL:DEV 5000
 sets the deviation of the pilot tone to 5 kHz

Manual operation: See "[Pilot Deviation](#)" on page 21

[:SOURCE<hw>]:BB:STEReo:PUWSint <PUWS>

Sets the way the FM signal is calculated in case of parameter update.

If this parameter is enabled and some parameters are changed, these parameters are updated but the FM signal will not be interrupted.

Disabling the parameter results in automatically re-calculation of the FM signal after each parameter update. This will disturb the pilot and the receiver has to be re-synchronized.

Parameters:

<PUWS> 0 | 1 | OFF | ON
 *RST: 1

Example:

SOUR:BB:STER:PUWS 1
 enables FM Stereo signal generation without interruption

Manual operation: See "[Perform settings update without signal interruption](#)" on page 22

[:SOURCE<hw>]:BB:STEReo:TRIGger:RMODE <RMode>

The command queries the current status of signal generation for all trigger modes with FM Stereo modulation on.

Parameters:

<RMode> STOP | RUN
RUN
 the signal is generated. A trigger event occurred in the triggered mode.
STOP
 the signal is not generated.
 *RST: STOP

Example:

BB:STER:TRIG:RMODE?
 queries the current status of signal generation.
 Response: RUN
 the signal is generated

Manual operation: See "[Running/Stopped](#)" on page 46

[:SOURce<hw>]:BB:STEReo[:TRIGger]:SEQuence <Sequence>

Sets the trigger mode.

Parameters:

<Sequence> AUTO
 AUTO
 The modulation signal is generated continuously.
 *RST: AUTO

Example: BB:STER:SEQ AUTO
 sets the Auto trigger mode

Manual operation: See "[Trigger Mode](#)" on page 46

4.2 RDS/RBDS Configurations

[:SOURce<hw>]:BB:STEReo:DS:CATalog?	58
[:SOURce<hw>]:BB:STEReo:DS:DEVIation	58
[:SOURce<hw>]:BB:STEReo:DS:DRATe?	59
[:SOURce<hw>]:BB:STEReo:DS:DSElect	59
[:SOURce<hw>]:BB:STEReo:DS:DSET	59
[:SOURce<hw>]:BB:STEReo:DS:GIM	60
[:SOURce<hw>]:BB:STEReo:DS:MODE	60
[:SOURce<hw>]:BB:STEReo:DS:PHASe	60
[:SOURce<hw>]:BB:STEReo:DS:STATe	61

[:SOURce<hw>]:BB:STEReo:DS:CATalog?

Reads out the files with the group list settings in the default directory.

The directory is set using command `MMEM:CDIRectory`. A path can also be specified, in which case the files in the specified directory are read. The file extension may be omitted. Only files with the file extension `*.fm_gt` will be listed.

Return values:

<Catalog> string

Example: MMEM:CDIR '`<root>FMStereo`'
 sets the default directory
 SOUR:BB:STER:DS:CAT?
 reads out all the files with group lists settings in the default direc-
 tory
 Response: `fm_stereo_GL1, fm_stereo_GL2`

Usage: Query only

[:SOURce<hw>]:BB:STEReo:DS:DEVIation <Deviation>

Sets the frequency deviation of the RDS/RBDS subcarrier.

Parameters:

<Deviation> integer
 Range: 0 to 10000
 Increment: 50
 *RST: 2000

Example: SOUR:BB:STER:DS:DEV 5000
 sets the deviation to 5 kHz

Manual operation: See "[Deviation](#)" on page 23

[[:SOURce<hw>]:BB:STEReo:DS:DRATe?

Queries the data rate.

Return values:

<DRate> float
 Range: 1187.5 to 1187.5
 Increment: 0.1
 *RST: 1187.5

Example: SOUR:BB:STER:DS:DRATe?
 queries the data rate
 Response: 1187.5

Usage: Query only

Manual operation: See "[Data Rate](#)" on page 23

[[:SOURce<hw>]:BB:STEReo:DS:DSElect <DSelect>

Selects the group list.

Setting parameters:

<DSelect> string

Example: BB:STER:DS:DSET GRPL
 selects group lists
 BB:STER:DS:DSEL 'fm_group_list'
 selects the group list file

Usage: Setting only

Manual operation: See "[Data Set](#)" on page 23

[[:SOURce<hw>]:BB:STEReo:DS:DSET <DSet>

Selects and activates the RDS/RBDS data set.

Parameters:

<DSet> UDGRoups | GRPList

UDGRoups

User-defined Groups

GRPList

the RDS/RBDS parameter are loaded from group lists files

*RST: UDGRoups

Example:

BB:STER:DS:DSET GRPL

selects group list files

Manual operation: See "[Data Set](#)" on page 23

[:SOURce<hw>]:BB:STEReo:DS:GIM <Gim>

Sets the input method.

Parameters:

<Gim> MSGFormat | HEXFormat

MSGFormat

Message Format

HEXFormat

Hex Format

*RST: MSGFormat

Example:

BB:STEReo:DS:GIM HEXF

selects the group input method Hex Format

Manual operation: See "[Groups Input Method](#)" on page 24

[:SOURce<hw>]:BB:STEReo:DS:MODE <Mode>

Selects the standard, RDS (Radio Data System) or RBDS (Radio Broadcast Data System), the signal is generated for.

Parameters:

<Mode> RDS | RBDS

*RST: RDS

Example:

SOUR:BB:STER:DS:MODE RBDS

selects the Radio Broadcast Data System.

Manual operation: See "[Standard](#)" on page 24

[:SOURce<hw>]:BB:STEReo:DS:PHASe <Phase>

Selects the phase of the RDS/RBDS subcarrier (with respect to the 38 kHz subcarrier).

Parameters:

<Phase> float
 Range: 0 to 359.9
 Increment: 0.1
 *RST: 0

Example: SOUR:BB:STER:DS:PHase 10.1
 sets a phase of 10.1 degrees.

Manual operation: See "Phase" on page 23

[:SOURce<hw>]:BB:STEReo:DS:STATe <State>

Activates/deactivates RDS/RBDS function.

Parameters:

<State> 0 | 1 | OFF | ON
 *RST: ON

Example: SOUR:BB:STER:DS:STAT ON
 activates the RDS/RBDS function

Manual operation: See "State" on page 23

4.3 Group Hex Settings

[:SOURce<hw>]:BB:STEReo:GHEX:CATalog?	61
[:SOURce<hw>]:BB:STEReo:GHEX:DATA<ch0>:BLOCk<st>	62
[:SOURce<hw>]:BB:STEReo:GHEX:LOAD	62
[:SOURce<hw>]:BB:STEReo:GHEX:NOENtries	62
[:SOURce<hw>]:BB:STEReo:GHEX:PRESet	62
[:SOURce<hw>]:BB:STEReo:GHEX:STORE	63

[:SOURce<hw>]:BB:STEReo:GHEX:CATalog?

Reads out the files in hex format with the group list settings in the default directory.

The directory is set using command `M MEM:CDIRectory`. A path can also be specified, in which case the files in the specified directory are read. The file extension may be omitted. Only files with the file extension `*.fm_ghex` will be listed.

Return values:

<Catalog> string

Example: `M MEM:CDIR '<root>FMStereo'`
 sets the default directory
`SOUR:BB:STER:GHEX:CAT?`
 reads out all the files in hex format with group lists settings in the default directory
 Response: `fm_stereo_GL_hex1, fm_stereo_GL_hex2`

Usage: Query only

[:SOURCE<hw>]:BB:STEReo:GHEX:DATA<ch0>:BLOCk<st> <Block>

Sets the block data.

Parameters:

<Block> integer
 Range: 0 to #H3FFFFFFF
 *RST: 0

Example: SOUR:BB:STER:GHEX:DATA2:BLOC3 #HA6BE
 sets the hex value #HA6BE for block 3 at group hex row index 2.

Manual operation: See "[Block 1 .. 4 \(Group Hex Table\)](#)" on page 44

[:SOURCE<hw>]:BB:STEReo:GHEX:LOAD <Load>

Loads the selected file with group hex settings.

The directory is set using command `MMEM:CDIRectory`. A path can also be specified, in which case the files in the specified directory are read. The file extension may be omitted. Only files with the file extension `*.fm_ghex` will be loaded.

Setting parameters:

<Load> string

Example: SOUR:BB:STER:GHEX:LOAD 'fm_stereo_GL_hex1'
 loads the file `fm_stereo_GL_hex1.fm`

Usage: Setting only

Manual operation: See "[Load Hex Data](#)" on page 45

[:SOURCE<hw>]:BB:STEReo:GHEX:NOENtries <NoEntries>

Sets the number of used group hex entries.

Parameters:

<NoEntries> integer
 Range: 1 to 64
 *RST: 1

Example: SOUR:BB:STER:GHEX:NOEN 5
 selects 3 used group hex entries for signal generation

Manual operation: See "[Used Entries](#)" on page 45

[:SOURCE<hw>]:BB:STEReo:GHEX:PRESet

Resets the group hex table.

Example: SOURce1:BB:STEReo:GHEX:PRESet

Usage: Event

Manual operation: See "Preset Hex Table" on page 44

[:SOURce<hw>]:BB:STEReo:GHEX:STORe <Store>

Stores the current RDS/RBDS Group Hex Settings into the selected file. The directory is set using command `MMEM:CDIRectory`. A path can also be specified, in which case the files in the specified directory are read. Only the file name has to be entered.

Setting parameters:

<Store> <file name>

Example: `SOUR:BB:STER:GHEX:STOR 'fm_groups'`
saves the RDS/RBDS Group Hex Settings into the file

Usage: Setting only

4.4 RDS/RBDS Group Settings

<code>[:SOURce<hw>]:BB:STEReo:GRPS:AGPReset</code>	64
<code>[:SOURce<hw>]:BB:STEReo:GRPS:CMNS:PI</code>	64
<code>[:SOURce<hw>]:BB:STEReo:GRPS:CMNS:PTY</code>	65
<code>[:SOURce<hw>]:BB:STEReo:GRPS:CMNS:TP</code>	65
<code>[:SOURce<hw>]:BB:STEReo:GRPS:GT<st0>:ABFLag</code>	65
<code>[:SOURce<hw>]:BB:STEReo:GRPS:GT<st0>:AFON:DATA<ch0></code>	65
<code>[:SOURce<hw>]:BB:STEReo:GRPS:GT<st0>:AFON:NOENtries</code>	66
<code>[:SOURce<hw>]:BB:STEReo:GRPS:GT<st0>:AFON:STATe</code>	66
<code>[:SOURce<hw>]:BB:STEReo:GRPS:GT<st0>:ALTF:DATA<ch0></code>	67
<code>[:SOURce<hw>]:BB:STEReo:GRPS:GT<st0>:ALTF:NOENtries</code>	67
<code>[:SOURce<hw>]:BB:STEReo:GRPS:GT<st0>:DATE</code>	67
<code>[:SOURce<hw>]:BB:STEReo:GRPS:GT<st0>:DID:ARTHead</code>	68
<code>[:SOURce<hw>]:BB:STEReo:GRPS:GT<st0>:DID:COMPressed</code>	68
<code>[:SOURce<hw>]:BB:STEReo:GRPS:GT<st0>:DID:DATA</code>	68
<code>[:SOURce<hw>]:BB:STEReo:GRPS:GT<st0>:DID:DPTY</code>	69
<code>[:SOURce<hw>]:BB:STEReo:GRPS:GT<st0>:DID:STEReo</code>	69
<code>[:SOURce<hw>]:BB:STEReo:GRPS:GT<st0>:INPMethod</code>	69
<code>[:SOURce<hw>]:BB:STEReo:GRPS:GT<st0>:LION:EG</code>	69
<code>[:SOURce<hw>]:BB:STEReo:GRPS:GT<st0>:LION:ILS</code>	70
<code>[:SOURce<hw>]:BB:STEReo:GRPS:GT<st0>:LION:LA</code>	70
<code>[:SOURce<hw>]:BB:STEReo:GRPS:GT<st0>:LION:LSN</code>	70
<code>[:SOURce<hw>]:BB:STEReo:GRPS:GT<st0>:LION:STATe</code>	71
<code>[:SOURce<hw>]:BB:STEReo:GRPS:GT<st0>:LOTime</code>	71
<code>[:SOURce<hw>]:BB:STEReo:GRPS:GT<st0>:MFL:DATA<ch0>:MF</code>	72
<code>[:SOURce<hw>]:BB:STEReo:GRPS:GT<st0>:MFL:DATA<ch0>:TF</code>	72
<code>[:SOURce<hw>]:BB:STEReo:GRPS:GT<st0>:MFL:NOENtries</code>	73
<code>[:SOURce<hw>]:BB:STEReo:GRPS:GT<st0>:MFL:STATe</code>	73
<code>[:SOURce<hw>]:BB:STEReo:GRPS:GT<st0>:MVSWitch</code>	73
<code>[:SOURce<hw>]:BB:STEReo:GRPS:GT<st0>:PINon:PIN</code>	74

[:SOURce<hw>]:BB:STEReo:GRPS:GT<st0>:PINon:STATe.....	74
[:SOURce<hw>]:BB:STEReo:GRPS:GT<st0>:PION.....	75
[:SOURce<hw>]:BB:STEReo:GRPS:GT<st0>:PSName.....	75
[:SOURce<hw>]:BB:STEReo:GRPS:GT<st0>:PSOn:PSName.....	75
[:SOURce<hw>]:BB:STEReo:GRPS:GT<st0>:PSOn:STATe.....	76
[:SOURce<hw>]:BB:STEReo:GRPS:GT<st0>:PTName.....	76
[:SOURce<hw>]:BB:STEReo:GRPS:GT<st0>:PTYTa:PTY.....	76
[:SOURce<hw>]:BB:STEReo:GRPS:GT<st0>:PTYTa:STATe.....	77
[:SOURce<hw>]:BB:STEReo:GRPS:GT<st0>:PTYTa:TA.....	77
[:SOURce<hw>]:BB:STEReo:GRPS:GT<st0>:RADText.....	77
[:SOURce<hw>]:BB:STEReo:GRPS:GT<st0>:STATe.....	78
[:SOURce<hw>]:BB:STEReo:GRPS:GT<st0>:SYSDate.....	78
[:SOURce<hw>]:BB:STEReo:GRPS:GT<st0>:SYSTime.....	78
[:SOURce<hw>]:BB:STEReo:GRPS:GT<st0>:TA.....	79
[:SOURce<hw>]:BB:STEReo:GRPS:GT<st0>:TABFlag.....	79
[:SOURce<hw>]:BB:STEReo:GRPS:GT<st0>:TAON.....	79
[:SOURce<hw>]:BB:STEReo:GRPS:GT<st0>:TIME.....	80
[:SOURce<hw>]:BB:STEReo:GRPS:GT<st0>:TPON.....	80
[:SOURce<hw>]:BB:STEReo:GRPS:GT<st0>:TTIME.....	80
[:SOURce<hw>]:BB:STEReo:GRPS:GT<st0>:UMT:DATA<ch0>:BLOCk<user>.....	81
[:SOURce<hw>]:BB:STEReo:GRPS:GT<st0>:UMT:NOENtries.....	81
[:SOURce<hw>]:BB:STEReo:GRPS:GT<st0>:USRDate.....	81
[:SOURce<hw>]:BB:STEReo:GRPS:GT<st0>:USRTIME.....	82
[:SOURce<hw>]:BB:STEReo:GRPS:GT<st0>:VERsion.....	82
[:SOURce<hw>]:BB:STEReo:GRPS:PRESet.....	83
[:SOURce<hw>]:BB:STEReo:GRPS:STORe.....	83

[:SOURce<hw>]:BB:STEReo:GRPS:AGPRreset

Sets the parameter values of the active group to the default settings.

Example: BB:STER:GRPS:AGPR
sets the active group ro default

Usage: Event

[:SOURce<hw>]:BB:STEReo:GRPS:CMNS:PI <Pi>

Sets the parameter PI (Program Identification). The input format is hex format or decimal format with 4 symbols length.

Parameters:
<Pi> integer
Range: 0 to #HFFFF
*RST: #HD238

Example: SOUR:BB:STER:GRPS:CMNS:PI #HAB18
sets the PI to #HAB18

Manual operation: See "Program Identification (PI)" on page 25

[:SOURce<hw>]:BB:STEReo:GRPS:CMNS:PTY <Pty>

Sets the program type number. The PTY number identifies the content of the program.

Parameters:

<Pty> integer
 Range: 1 to 31
 *RST: 1

Example: SOUR:BB:STER:GRPS:CMNS:PTY 4
 sets the PTY number

Manual operation: See "[Program Type \(PTY\) Number](#)" on page 26

[:SOURce<hw>]:BB:STEReo:GRPS:CMNS:TP <Tp>

Enables/disables the traffic program.

Parameters:

<Tp> 0 | 1 | OFF | ON
 *RST: OFF

Example: SOUR:BB:STER:GRPS:CMNS:TP ON
 enables sending of TP.

Manual operation: See "[Traffic Program \(TP\)](#)" on page 27

[:SOURce<hw>]:BB:STEReo:GRPS:GT<st0>:ABFLag <AbFlag>

Sets the A/B Flag to 0 (disabled parameter) or 1 (enabled parameter).

Parameters:

<AbFlag> 0 | 1 | OFF | ON
 *RST: OFF

Example: SOUR:BB:STER:GRPS:GT10:ABFL ON
 sets the A/B Flag for group type 10 to 1.

Manual operation: See "[A/B Flag](#)" on page 29

[:SOURce<hw>]:BB:STEReo:GRPS:GT<st0>:AFON:DATA<ch0> <Data>

Sets the alternative frequency (AF) for other networks.

This command is enabled only for group type 14A.

Suffix:

<st0> 14
 <ch0> 0 .. 24

Parameters:

<Data> float
 Range: 87.6 to 107.9
 Increment: 0.1
 *RST: 87.6

Example:

SOUR:BB:STER:GRPS:GT14:AFON:NOEN 10
 enables using of 10 AFs.
 SOUR:BB:STER:GRPS:GT14:AFON:DATA3 108.5
 sets the alternative frequency at index 3 to 108.5 MHz

Manual operation: See ["Frequency/ MHz \(Alternative Frequency List ON\)"](#) on page 39

[:SOURCE<hw>]:BB:STEReo:GRPS:GT<st0>:AFON:NOENtries <NoEntries>

Sets the number of alternative frequency of other networks to be configured. A maximal number of 25 AFs can be configured.

This command is enabled only for group type 14A.

Suffix:

<st0> 14

Parameters:

<NoEntries> integer
 Range: 0 to 25
 *RST: 0

Example:

SOUR:BB:STER:GRPS:GT14:AFON:NOEN 10
 enables using of 10 AFs.

Manual operation: See ["No. Of Used Frequencies \(Alternative Frequency List ON\)"](#) on page 39

[:SOURCE<hw>]:BB:STEReo:GRPS:GT<st0>:AFON:STATe <State>

Enables/disables using AF method A for other networks.

This command is enabled only for group type 14A.

Suffix:

<st0> 14

Parameters:

<State> 0 | 1 | OFF | ON
 *RST: 0

Example:

SOUR:BB:STER:GRPS:GT14:AFON:STAT ON
 enables using of Alternative Frequency (ON)

Manual operation: See ["State \(Alternative Frequency\)"](#) on page 39

[:SOURce<hw>]:BB:STEReo:GRPS:GT<st0>:ALTF:DATA<ch0> <Data>

Sets the alternative frequency (AF) for the broadcast frequency.

This command is enabled only for group type 0A.

Suffix:

<st0> 0
 <ch0> 0 .. 24

Parameters:

<Data> float
 Range: 87.6 to 107.9
 Increment: 0.1
 *RST: 87.6

Example:

SOUR:BB:STER:GRPS:GT0:ALTF:NOEN 10
 enables using of 10 AFs.
 SOUR:BB:STER:GRPS:GT0:ALTF:DATA3 108.5
 sets the alternative frequency at index 3 to 108.5 MHz

Manual operation: See "[Frequency/ MHz \(Alternative Frequency List\)](#)" on page 33

[:SOURce<hw>]:BB:STEReo:GRPS:GT<st0>:ALTF:NOENTries <NoEntries>

Sets the number of alternative frequency to be configured. A maximal number of 25 AFs can be configured.

This command is enabled only for group type 0A.

Suffix:

<st0> 0

Parameters:

<NoEntries> integer
 Range: 0 to 25
 *RST: 0

Example:

SOUR:BB:STER:GRPS:GT0:ALTF:NOEN 10
 enables using of 10 AFs.

Manual operation: See "[No. Of Used Frequencies \(Alternative Frequency List\)](#)" on page 33

[:SOURce<hw>]:BB:STEReo:GRPS:GT<st0>:DATE <Date>

Sets the date type to user date (USRDate) or system date (SYSDate).

This command is enabled only for group type 4A.

Suffix:

<st0> 4

Parameters:

<Date> SYSDate | USRDate
 *RST: SYSDate

Example:

SOUR:BB:STER:GRPS:GT4:DATE USRD
 selects user date

Manual operation: See ["Date"](#) on page 34

[:SOURce<hw>]:BB:STEReo:GRPS:GT<st0>:DID:ARTHead <ArtHead>

Enables/disables using of Artificial Head.

Parameters:

<ArtHead> 0 | 1 | OFF | ON
 *RST: OFF

Example:

SOUR:BB:STER:GRPS:GT0:DID:ARTH ON
 enables artificial head

Manual operation: See ["Artificial Head - DI"](#) on page 32

[:SOURce<hw>]:BB:STEReo:GRPS:GT<st0>:DID:COMPressed <Compressed>

Enables/disables the compressed bit of DI.

Parameters:

<Compressed> 0 | 1 | OFF | ON
 *RST: OFF

Example:

SOUR:BB:STER:GRPS:GT0:DID:COMP ON
 enables the compressed bit

Manual operation: See ["Compressed - DI"](#) on page 32

[:SOURce<hw>]:BB:STEReo:GRPS:GT<st0>:DID:DATA <Data>

Queries the current decoder operating mode (mono, stereo, rtc.) as selected for group type 0.

This command is enabled only for group type 0 and 15B.

Suffix:

<st0> 0 .. 15

Parameters:

<Data> integer
 Range: 0 to #HF
 *RST: 0

Example:

SOUR:BB:STER:GRPS:GT15:DID:DATA?
 queries the DI
 Response: 0101

Manual operation: See "[Decoder Identification \(DI\)](#)" on page 32

[:SOURce<hw>]:BB:STEReo:GRPS:GT<st0>:DID:DPTY <DPty>

Enables/disables dynamically PTY switching.

Parameters:

<DPty> 0 | 1 | OFF | ON
 *RST: OFF

Example: SOUR:BB:STER:GRPS:GT0:DID:DPTY OFF
 disables dynamic PTY

Manual operation: See "[Dynamic PTY - DI](#)" on page 32

[:SOURce<hw>]:BB:STEReo:GRPS:GT<st0>:DID:STEReo <Stereo>

Sets the mono/stereo switch in the DI.

Parameters:

<Stereo> 0 | 1 | OFF | ON
 *RST: OFF

Example: SOUR:BB:STER:GRPS:GT0:DID:STER OFF
 sets the DI bit to mono

Manual operation: See "[Stereo - DI](#)" on page 33

[:SOURce<hw>]:BB:STEReo:GRPS:GT<st0>:INPMethod <InpMethod>

Selects the input format of the RDS/RBDS parameters.

Suffix:

<st0> 0 .. 15

Parameters:

<InpMethod> PARameters | UDMessAge

PARameters

Configuration based on direct parameter input

UDMessAge

User defined messages are used to configure the group types

*RST: PARameters

Example: SOUR:BB:STER:GRPS:GT:INPM UDM
 user defined messages are used.

Manual operation: See "[Input Method](#)" on page 28

[:SOURce<hw>]:BB:STEReo:GRPS:GT<st0>:LION:EG <Eg>

Enables/disables the Extended Generic Indicator EG.

This command is enabled only for group type 14A.

Suffix:

<st0> 14

Parameters:

<Eg> 0 | 1 | OFF | ON
*RST: 0

Example:

SOUR:BB:STER:GRPS:GT14:LION:EG ON
enables the Extended Generic Indicator EG

Manual operation: See "[Extended Generic Indicator \(EG\)](#)" on page 41

[:SOURCE<hw>]:BB:STEReo:GRPS:GT<st0>:LION:ILS <lls>

Enables/disables the International Linkage Set indicator ILS.

This command is enabled only for group type 14A.

Suffix:

<st0> 14

Parameters:

<lls> 0 | 1 | OFF | ON
*RST: 0

Example:

SOUR:BB:STER:GRPS:GT14:LION:ILS ON
enables ILS. i.e. sets ILS=1

Manual operation: See "[International Linkage Set Ind.](#)" on page 41

[:SOURCE<hw>]:BB:STEReo:GRPS:GT<st0>:LION:LA <La>

Enables/disables the Linkage Actuator LA.

This command is enabled only for group type 14A.

Suffix:

<st0> 14

Parameters:

<La> 0 | 1 | OFF | ON
*RST: 0

Example:

SOUR:BB:STER:GRPS:GT14:LION:LA ON
enables LA, i.e. LA=1

Manual operation: See "[Linkage Actuator \(LA\)](#)" on page 40

[:SOURCE<hw>]:BB:STEReo:GRPS:GT<st0>:LION:LSN <Lsn>

Sets the Linkage Set Number LSN.

The LSN is a 12 bit number.

This command is enabled only for group type 14A.

Suffix:

<st0> 14

Parameters:

<Lsn> 12 bits

Example:

SOUR:BB:STER:GRPS:GT14:LION:LSN #H78
sets the LSN to #H78

Manual operation: See "[Linkage Set Number \(LSN\)](#)" on page 41

[:SOURce<hw>]:BB:STEReo:GRPS:GT<st0>:LION:STATe <State>

Enables/disables using of Linkage Information.

This command is enabled only for group type 14A.

Suffix:

<st0> 14

Parameters:

<State> 0 | 1 | OFF | ON

*RST: 0

Example:

SOUR:BB:STER:GRPS:GT14:LION:STAT ON
enables using of Linking Information

Manual operation: See "[State \(Linkage Information\)](#)" on page 40

[:SOURce<hw>]:BB:STEReo:GRPS:GT<st0>:LOTime <LoTime>

Sets the local offset time expressed in multiples of half hours within the range -12h to +12h.

The time is the sum of the user time and the local time offset.

This command is enabled only for group type 4A.

Suffix:

<st0> 4

Parameters:

<LoTime> string

Range: -12,00 to 12,00

*RST: 0:00

Example:

SOUR:BB:STER:GRPS:GT4:TIME USRT
enables user time

SOUR:BB:STER:GRPS:GT4:USRT 12,15
sets the user time

SOUR:BB:STER:GRPS:GT4:LOT 5,30
sets the local offset time, i.e. the local time is 17:45

Manual operation: See "[Local Offset Time](#)" on page 34

[:SOURce<hw>]:BB:STEReo:GRPS:GT<st0>:MFL:DATA<ch0>:MF <Mf>

Sets a mapped frequency entry.

Sets a mapped frequency entry. The following variant codes will be used to encode the frequency settings:

- Variant Code 5 (binary 0101) Mapped FM frequency 1 (ON)
- Variant Code 6 (binary 0110) Mapped FM frequency 2(ON)
- Variant Code 7 (binary 0111) Mapped FM frequency 3(ON)
- Variant Code 8 (binary 1000) Mapped FM frequency 4(ON)
- Variant Code 9 (binary 1001) Mapped AM frequency(ON)

This command is enabled only for group type 14A.

Suffix:

<st0> 14

<ch0> 0 .. 4

Parameters:

<Mf> float

Range: depends on channel: 87.6 .. 107.9 MHz (Data 0..3)
or 153 .. 279 kHz/531 .. 1602 kHz (Data 4)

Increment: 0.001

*RST: depends on channel

Example:

BB:STER:GRPS:GT14:MFL:MF2 101.3

sets the mapped frequency at index 2 to 101.3MHz.

BB:STER:GRPS:GT14:MFL:MF4 532

sets the mapped frequency at index 4 to 532 kHz.

Manual operation: See "[Mapped Frequency \(ON\)/ MHz](#)" on page 40

[:SOURce<hw>]:BB:STEReo:GRPS:GT<st0>:MFL:DATA<ch0>:TF <Tf>

Sets a tuning frequency entry.

The following variant codes will be used to encode the frequency settings:

- Variant Code 5 (binary 0101) Tuning FM frequency 1 (ON)
- Variant Code 6 (binary 0110) Tuning FM frequency 2 (ON)
- Variant Code 7 (binary 0111) Tuning FM frequency 3 (ON)
- Variant Code 8 (binary 1000) Tuning FM frequency 4 (ON)
- Variant Code 9 (binary 1001) Tuning AM frequency (ON)

This command is enabled only for group type 14A.

Suffix:

<st0> 14

<ch0> 0 .. 4

Parameters:

<Tf> float
 Range: depends on channel: 87.6 .. 107.9 MHz (Data 0..3)
 or 153 .. 279 kHz/531 .. 1602 kHz (Data 4)
 Increment: 0.001
 *RST: depends on channel

Example:

BB:STER:GRPS:GT14:MFL:TF2 87.7
 sets the tuning frequency at index 2 to 87.7 MHz.

Manual operation: See ["Tuning Frequency \(TN\)/ MHz"](#) on page 40

[:SOURCE<hw>]:BB:STEReo:GRPS:GT<st0>:MFL:NOENtries <NoEntries>

Sets the number of mapped frequency to be configured. A maximal number of 5 frequencies can be configured.

This command is enabled only for group type 14A.

Suffix:

<st0> 14

Parameters:

<NoEntries> integer
 Range: 0 to 5
 *RST: 0

Example:

SOUR:BB:STER:GRPS:GT14:MFL:NOEN 3
 sets 3 mapped frequencies

Manual operation: See ["No. Of Used Frequencies \(Mapped Frequency List\)"](#) on page 40

[:SOURCE<hw>]:BB:STEReo:GRPS:GT<st0>:MFL:STATe <State>

Enables/disables using of mapped frequencies.

This command is enabled only for group type 14A.

Suffix:

<st0> 14

Parameters:

<State> 0 | 1 | OFF | ON
 *RST: 0

Example:

SOUR:BB:STER:GRPS:GT14:MFL:STAT ON
 enables using of mapped sequences

Manual operation: See ["State \(Mapped Frequencies\)"](#) on page 39

[:SOURCE<hw>]:BB:STEReo:GRPS:GT<st0>:MVSWitch <MvSwitch>

For GT0, enables switching between speech and music transmission.

For GT15B, this command is query only.

Suffix:

<st0> 0 | 15

Parameters:

<MvSwitch> MUSic | VOICe
*RST: MUSic

Example:

SOUR:BB:STER:GRPS:GT0:MVSW VOIC
enables voice transmission
SOUR:BB:STER:GRPS:GT15:MVSW?
queries the state of Music/Voice parameter
Response: Voice

Manual operation: See "[Music/Voice Switch](#)" on page 32

[:SOURCE<hw>]:BB:STEReo:GRPS:GT<st0>:PINon:PIN <Pin>

Enters the program item number (PIN) of other networks.

This command is enabled only for group type 14A.

Suffix:

<st0> 14

Parameters:

<Pin> 16 bits

Example:

SOUR:BB:STER:GRPS:GT14:PIN:STAT ON
enables using of PIN (ON)
SOUR:BB:STER:GRPS:GT14:PIN:PIN #H2AB3
sets the PIN of other networks

Manual operation: See "[Program Item Number \(PIN\) - Other Networks \(ON\)](#)" on page 42

[:SOURCE<hw>]:BB:STEReo:GRPS:GT<st0>:PINon:STATE <State>

Enables/disables using of PIN (ON).

This command is enabled only for group type 14A.

Suffix:

<st0> 14

Parameters:

<State> 0 | 1 | OFF | ON
*RST: 0

Example:

SOUR:BB:STER:GRPS:GT14:PIN:STAT ON
enables using of PIN (ON)

Manual operation: See "[State \(PIN\) - Other Networks \(ON\)](#)" on page 42

[:SOURCE<hw>]:BB:STEReo:GRPS:GT<st0>:PION <PiOn>

Sets the parameter Program Identification of other networks in hex format.

This command is enabled only for group type 14A.

Suffix:

<st0> 14

Parameters:

<PiOn> 16 bits
 Range: #H0000 to #HFFFF
 *RST: #HD238

Example: SOUR:BB:STER:GRPS:GT14:PION #H2D3A
 sets the PI (ON)

Manual operation: See "[Program Identification \(PI\) - Other Networks \(ON\)](#)"
 on page 36

[:SOURCE<hw>]:BB:STEReo:GRPS:GT<st0>:PSName <PsName>

Enters the program service (PS) name.

The default maximum length of PS is 8 characters.

Suffix:

<st0> 0

Parameters:

<PsName> string
 *RST: SMU-FM

Example: SOUR:BB:STER:GRPS:GT0:PSN 'Program 1'
 sets the PS name.

Manual operation: See "[Program Service Name](#)" on page 33

[:SOURCE<hw>]:BB:STEReo:GRPS:GT<st0>:PSON:PSName <PsName>

Enters the program service name (max 8 characters) of other networks.

This command is enabled only for group type 14A.

Suffix:

<st0> 14

Parameters:

<PsName> string
 *RST: SMU-FM2

Example: SOUR:BB:STER:GRPS:GT14:PSON:STAT ON
 enables using of program service name (ON).
 SOUR:BB:STER:GRPS:GT14:PSON:PSN 'PrServ1'
 sets the program service name (ON)

Manual operation: See ["Program Service \(PS\) Name - Other Networks \(ON\)"](#) on page 39

[:SOURCE<hw>]:BB:STEReo:GRPS:GT<st0>:PSON:STATe <State>

Enables/disables sending of program service name of other networks PS (ON).

This command is enabled only for group type 14A.

Suffix:

<st0> 14

Parameters:

<State> 0 | 1 | OFF | ON

*RST: 0

Example:

SOUR:BB:STER:GRPS:GT14:PSON:STAT ON

enables using of program service name (ON).

Manual operation: See ["State \(Program Service\) - Other Networks \(ON\)"](#) on page 39

[:SOURCE<hw>]:BB:STEReo:GRPS:GT<st0>:PTName <PtName>

Enters the program type name (max 8 characters).

This command is enabled only for group type 10A.

Suffix:

<st0> 10

Parameters:

<PtName> <Program Type Name>

*RST: Music

Example:

SOUR:BB:STER:GRPS:GT10:PTN 'Music Only'

enters the program type name

Manual operation: See ["Program Type Name"](#) on page 29

[:SOURCE<hw>]:BB:STEReo:GRPS:GT<st0>:PTYTa:PTY <Pty>

Sets the program type number of other networks.

This command is enabled only for group type 14A.

Suffix:

<st0> 14

Parameters:

<Pty> integer

Range: 0 to 31

*RST: 0

Example: SOUR:BB:STER:GRPS:GT14:PTYT:STAT ON
enables PTY/TA of other networks
SOUR:BB:STER:GRPS:GT14:PTYT:PTY 15
sets the program type (ON)

Manual operation: See "[Program Type \(PTY\) Number - Other Networks \(ON\)](#)" on page 41

[:SOURce<hw>]:BB:STEReo:GRPS:GT<st0>:PTYTa:STATE <State>

Enables/disables using of PTY (ON) and TA (ON).

This command is enabled only for group type 14A.

Parameters:

<State> 0 | 1 | OFF | ON
*RST: OFF

Example: SOUR:BB:STER:GRPS:GT14:PTYT:STAT ON
enables PTY/TA of other networks

Manual operation: See "[State \(PTY/TA\) - Other Networks \(ON\)](#)" on page 41

[:SOURce<hw>]:BB:STEReo:GRPS:GT<st0>:PTYTa:TA <Ta>

Enables/disables the traffic announcement (TA) of other networks.

This command is enabled only for group type 14A.

Suffix:

<st0> 14

Parameters:

<Ta> 0 | 1 | OFF | ON
*RST: 0

Example: SOUR:BB:STER:GRPS:GT14:PTYT:STAT ON
enables PTY/TA of other networks
SOUR:BB:STER:GRPS:GT14:PTYT:TAON ON
enables traffic communication (ON)

[:SOURce<hw>]:BB:STEReo:GRPS:GT<st0>:RADText <RadText>

Sets the radio text.

This command is enabled only for group type 2.

Suffix:

<st0> 2

Parameters:

<RadText> string
*RST: SMU-Radio

Example: `SOUR:BB:STER:GRPS:GT2:RADT 'RADIO MESSAGE'`
sets the radio text

Manual operation: See ["Radio Text"](#) on page 29

[:SOURCE<hw>]:BB:STEReo:GRPS:GT<st0>:STATe <State>

Enables/disables the transmission of the corresponding group type.

Suffix:

<st0> 0 .. 15

Parameters:

<State> 0 | 1 | OFF | ON

*RST: 1

Example: `SOUR:BB:STER:GRPS:GT12:STAT ON`
group 12 will be transmitted

Manual operation: See ["State"](#) on page 30

[:SOURCE<hw>]:BB:STEReo:GRPS:GT<st0>:SYSDate <SysDate>

Queries the system date.

This command is enabled only for group type 4A.

Suffix:

<st0> 14

Parameters:

<SysDate> string

Range: 01,01,2006 to 31,12,9999

Example: `SOUR:BB:STER:GRPS:GT4:DATE SYSD`
selects system date
`SOUR:BB:STER:GRPS:GT4:SYSD?`
queries the system date
Response: 3,6,2008

Manual operation: See ["System Date"](#) on page 34

[:SOURCE<hw>]:BB:STEReo:GRPS:GT<st0>:SYSTime <SysTime>

Queries the system time.

This command is enabled only for group type 4A.

Suffix:

<st0> 4

Parameters:

<SysTime> string

Range: 00,00 to 23,59

Example: SOUR:BB:STER:GRPS:GT4:TIME SYSD
selects system date
SOUR:BB:STER:GRPS:GT4:SYST?
queries the system time

Manual operation: See "[System Time](#)" on page 34

[:SOURce<hw>]:BB:STEReo:GRPS:GT<st0>:TA <Ta>

Enables/disables broadcasting of traffic announcement.

Parameters:

<Ta> 0 | 1 | OFF | ON
*RST: OFF

Example: SOUR:BB:STER:GRPS:GT0:TA ON
enables TA for group type 0

Manual operation: See "[Traffic Announcement](#)" on page 32

[:SOURce<hw>]:BB:STEReo:GRPS:GT<st0>:TABFlag <TabFlag>

Sets the Text A/B Flag to 0 (disabled parameter) or 1 (enabled parameter).

Parameters:

<TabFlag> 0 | 1 | OFF | ON
*RST: OFF

Example: SOUR:BB:STER:GRPS:GT2:TABF ON
sets the Text A/B Flag for group type 2 to 1.

Manual operation: See "[Text A/B Flag](#)" on page 29

[:SOURce<hw>]:BB:STEReo:GRPS:GT<st0>:TAON <TaOn>

Enables/disables the traffic announcement (TA) of other networks.

This command is enabled only for group type 14B.

Suffix:

<st0> 14

Parameters:

<TaOn> 0 | 1 | OFF | ON
*RST: 0

Example: SOUR:BB:STER:GRPS:GT14:TAON ON
enables TA (ON)

Manual operation: See "[Traffic Announcement \(TA\) - Other Networks \(ON\)](#)" on page 42

[:SOURce<hw>]:BB:STEReo:GRPS:GT<st0>:TIME <Time>

Sets the time type to system time (SYSTime) or user time (USRTTime).

This command is enabled only for group type 4A.

Suffix:

<st0> 4

Parameters:

<Time> SYSTime | USRTTime
*RST: SYSTime

Example: SOUR:BB:STER:GRPS:GT4:TIME USRT
selects user time

Manual operation: See ["Time"](#) on page 34

[:SOURce<hw>]:BB:STEReo:GRPS:GT<st0>:TPON <TpOn>

Enables/ disables the traffic program of other networks.

Parameters:

<TpOn> 0 | 1 | OFF | ON
*RST: OFF

Example: SOUR:BB:STER:GRPS:GT14:TPON ON
enables traffic program (ON)

Manual operation: See ["Traffic Program \(TP\) - Other Networks \(ON\)"](#) on page 37

[:SOURce<hw>]:BB:STEReo:GRPS:GT<st0>:TTIME <TTime>

Sets the group transmit time. The transmit time is the group repetition rate given as proportion. The sum of all transmit time is 100%.

Only groups with "State" set to On ([\[:SOURce<hw>\]:BB:STEReo:GRPS:GT<st0>:STATE](#)) are transmitted.

Suffix:

<st0> 0 .. 15

Parameters:

<TTime> integer
Range: 0 to 100
*RST: 40% (GT0), 10% (GT1), 15% (GT2), 4% (GT3), 2% (GT4..GT13), 10% (GT14), 1% (GT15)

Example: SOUR:BB:STER:GRPS:GT12:STAT ON
group 12 will be transmitted
SOUR:BB:STER:GRPS:GT12:TTIM 6
the transmission time of group 12 is 6%

Manual operation: See ["Tx Time"](#) on page 30

**[:SOURCE<hw>]:BB:STEReo:GRPS:GT<st0>:UMT:DATA<ch0>:BLOCK<user>
<Block>**

Sets the hex value for the corresponding block of the corresponding user message hex table row.

Checksum and offset are automatically calculated.

Suffix:

<st0> 0 .. 25

<ch0> 0 .. 31

<user> 2 .. 4

Parameters:

<Block> integer
 Range: 0 to #H1F
 *RST: 0

Example: SOUR:BB:STER:GRPS:GT0:UMT:DATA0:BLOCK2 #H1F
 sets block 2 to 1F

Manual operation: See "[Block 2 \(User Message Table\)](#)" on page 43

[:SOURCE<hw>]:BB:STEReo:GRPS:GT<st0>:UMT:NOENtries <NoEntries>

Sets the number of transmitted groups per message. A maximal number of 32 groups can be configured.

Suffix:

<st0> 0 .. 15

Parameters:

<NoEntries> integer
 Range: 0 to 32
 *RST: 1

Example: SOUR:BB:STER:GRPS:GT0:UMT:NOEN 4
 4 user defined messages will be used

Manual operation: See "[No. Of Message Entries \(User Message Table\)](#)"
 on page 43

[:SOURCE<hw>]:BB:STEReo:GRPS:GT<st0>:USRDate <UsrDate>

Sets the user date in format DD,MM,YYYY.

This command is enabled only for group type 4A.

Suffix:

<st0> 4

Parameters:

<UsrDate> DD,MM,YYYY
 Range: 01,01,2006 to 31,12,9999
 *RST: 01,01,2006

Example:

SOUR:BB:STER:GRPS:GT4:DATE USRD
 selects user date
 SOUR:BB:STER:GRPS:GT4:USRD '30,05,2008'
 sets the user date

Manual operation: See ["User Date"](#) on page 34

[:SOURce<hw>]:BB:STEReo:GRPS:GT<st0>:USRTime <UsrTime>

Sets the user time in format HH,MM. The time is the sum of the user time and the local time offset ([:SOURce<hw>] :BB:STEReo:GRPS:GT<st0>:LOTime).

This command is enabled only for group type 4A.

Suffix:

<st0> 4

Parameters:

<UsrTime> string
 Range: 00,00 to 23,59
 *RST: 00,00

Example:

SOUR:BB:STER:GRPS:GT4:TIME USRT
 selects user time
 SOUR:BB:STER:GRPS:GT4:USRT 12,15
 sets the user time

Manual operation: See ["User Time"](#) on page 34

[:SOURce<hw>]:BB:STEReo:GRPS:GT<st0>:VERSion <Version>

Sets the group type version of the corresponding group type.

Suffix:

<st0> 0 .. 15

Parameters:

<Version> A | B
A
 Group Type Version A
B
 Group Type Version B
 *RST: A

Example:

SOUR:BB:STER:GRPS:GT2:VERS B
 sets group type 2 with version B

Manual operation: See ["Group Type Version"](#) on page 29

[:SOURCE<hw>]:BB:STEReo:GRPS:PRESet

Sets all group parameter values to the default settings.

Example: SOURCE1:BB:STEReo:GRPS:PRESet

Usage: Event

Manual operation: See ["Set Groups to Default"](#) on page 25

[:SOURCE<hw>]:BB:STEReo:GRPS:STORe <Store>

Stores the current RDS/RBDS group settings into the selected file. The directory is set using command `MMEM:CDIRectory`. A path can also be specified, in which case the files in the specified directory are read. Only the file name has to be entered. RDS/RBDS group settings are stored as files with the specific file extension `*.fm_gt`.

Setting parameters:

<Store> string

Example: SOUR:BB:STER:GRPS:STOR 'fm_groups'
saves the RDS/RBDS setting into the file `fm_groups.fm_gt`

Usage: Setting only

Manual operation: See ["Save Groups"](#) on page 25

List of Commands

[:SOURCE<hw>]:BB:STEReo:AUDio:CATalog?	53
[:SOURCE<hw>]:BB:STEReo:AUDio:DSElect	54
[:SOURCE<hw>]:BB:STEReo:AUDio:EXTClock	54
[:SOURCE<hw>]:BB:STEReo:AUDio:LEVel	54
[:SOURCE<hw>]:BB:STEReo:AUDio:MODE	55
[:SOURCE<hw>]:BB:STEReo:AUDio:PREEmphasis	55
[:SOURCE<hw>]:BB:STEReo:AUDio[:FREQuency]	56
[:SOURCE<hw>]:BB:STEReo:DEViation	52
[:SOURCE<hw>]:BB:STEReo:DS:CATalog?	58
[:SOURCE<hw>]:BB:STEReo:DS:DEViation	58
[:SOURCE<hw>]:BB:STEReo:DS:DRATE?	59
[:SOURCE<hw>]:BB:STEReo:DS:DSElect	59
[:SOURCE<hw>]:BB:STEReo:DS:DSET	59
[:SOURCE<hw>]:BB:STEReo:DS:GIM	60
[:SOURCE<hw>]:BB:STEReo:DS:MODE	60
[:SOURCE<hw>]:BB:STEReo:DS:PHASe	60
[:SOURCE<hw>]:BB:STEReo:DS:STATe	61
[:SOURCE<hw>]:BB:STEReo:GHEX:CATalog?	61
[:SOURCE<hw>]:BB:STEReo:GHEX:DATA<ch0>:BLOCk<st>	62
[:SOURCE<hw>]:BB:STEReo:GHEX:LOAD	62
[:SOURCE<hw>]:BB:STEReo:GHEX:NOENtries	62
[:SOURCE<hw>]:BB:STEReo:GHEX:PRESet	62
[:SOURCE<hw>]:BB:STEReo:GHEX:STORe	63
[:SOURCE<hw>]:BB:STEReo:GRPS:AGPReset	64
[:SOURCE<hw>]:BB:STEReo:GRPS:CMNS:PI	64
[:SOURCE<hw>]:BB:STEReo:GRPS:CMNS:PTY	65
[:SOURCE<hw>]:BB:STEReo:GRPS:CMNS:TP	65
[:SOURCE<hw>]:BB:STEReo:GRPS:GT<st0>:ABFLag	65
[:SOURCE<hw>]:BB:STEReo:GRPS:GT<st0>:AFON:DATA<ch0>	65
[:SOURCE<hw>]:BB:STEReo:GRPS:GT<st0>:AFON:NOENtries	66
[:SOURCE<hw>]:BB:STEReo:GRPS:GT<st0>:AFON:STATe	66
[:SOURCE<hw>]:BB:STEReo:GRPS:GT<st0>:ALTF:DATA<ch0>	67
[:SOURCE<hw>]:BB:STEReo:GRPS:GT<st0>:ALTF:NOENtries	67
[:SOURCE<hw>]:BB:STEReo:GRPS:GT<st0>:DATE	67
[:SOURCE<hw>]:BB:STEReo:GRPS:GT<st0>:DID:ARTHHead	68
[:SOURCE<hw>]:BB:STEReo:GRPS:GT<st0>:DID:COMPRESSED	68
[:SOURCE<hw>]:BB:STEReo:GRPS:GT<st0>:DID:DATA	68
[:SOURCE<hw>]:BB:STEReo:GRPS:GT<st0>:DID:DPTY	69
[:SOURCE<hw>]:BB:STEReo:GRPS:GT<st0>:DID:STEReo	69
[:SOURCE<hw>]:BB:STEReo:GRPS:GT<st0>:INPMethod	69
[:SOURCE<hw>]:BB:STEReo:GRPS:GT<st0>:LION:EG	69
[:SOURCE<hw>]:BB:STEReo:GRPS:GT<st0>:LION:ILS	70
[:SOURCE<hw>]:BB:STEReo:GRPS:GT<st0>:LION:LA	70
[:SOURCE<hw>]:BB:STEReo:GRPS:GT<st0>:LION:LSN	70
[:SOURCE<hw>]:BB:STEReo:GRPS:GT<st0>:LION:STATe	71
[:SOURCE<hw>]:BB:STEReo:GRPS:GT<st0>:LOTTime	71
[:SOURCE<hw>]:BB:STEReo:GRPS:GT<st0>:MFL:DATA<ch0>:MF	72

[:SOURCE<hw>]:BB:STEReo:GRPS:GT<st0>:MFL:DATA<ch0>:TF.....	72
[:SOURCE<hw>]:BB:STEReo:GRPS:GT<st0>:MFL:NOENTries.....	73
[:SOURCE<hw>]:BB:STEReo:GRPS:GT<st0>:MFL:STATe.....	73
[:SOURCE<hw>]:BB:STEReo:GRPS:GT<st0>:MVSWitch.....	73
[:SOURCE<hw>]:BB:STEReo:GRPS:GT<st0>:PINon:PIN.....	74
[:SOURCE<hw>]:BB:STEReo:GRPS:GT<st0>:PINon:STATe.....	74
[:SOURCE<hw>]:BB:STEReo:GRPS:GT<st0>:PION.....	75
[:SOURCE<hw>]:BB:STEReo:GRPS:GT<st0>:PSName.....	75
[:SOURCE<hw>]:BB:STEReo:GRPS:GT<st0>:PSON:PSName.....	75
[:SOURCE<hw>]:BB:STEReo:GRPS:GT<st0>:PSON:STATe.....	76
[:SOURCE<hw>]:BB:STEReo:GRPS:GT<st0>:PTName.....	76
[:SOURCE<hw>]:BB:STEReo:GRPS:GT<st0>:PTYTa:PTY.....	76
[:SOURCE<hw>]:BB:STEReo:GRPS:GT<st0>:PTYTa:STATe.....	77
[:SOURCE<hw>]:BB:STEReo:GRPS:GT<st0>:PTYTa:TA.....	77
[:SOURCE<hw>]:BB:STEReo:GRPS:GT<st0>:RADText.....	77
[:SOURCE<hw>]:BB:STEReo:GRPS:GT<st0>:STATe.....	78
[:SOURCE<hw>]:BB:STEReo:GRPS:GT<st0>:SYSDate.....	78
[:SOURCE<hw>]:BB:STEReo:GRPS:GT<st0>:SYSTime.....	78
[:SOURCE<hw>]:BB:STEReo:GRPS:GT<st0>:TA.....	79
[:SOURCE<hw>]:BB:STEReo:GRPS:GT<st0>:TABFlag.....	79
[:SOURCE<hw>]:BB:STEReo:GRPS:GT<st0>:TAON.....	79
[:SOURCE<hw>]:BB:STEReo:GRPS:GT<st0>:TIME.....	80
[:SOURCE<hw>]:BB:STEReo:GRPS:GT<st0>:TPON.....	80
[:SOURCE<hw>]:BB:STEReo:GRPS:GT<st0>:TTIme.....	80
[:SOURCE<hw>]:BB:STEReo:GRPS:GT<st0>:UMT:DATA<ch0>:BLOCk<user>.....	81
[:SOURCE<hw>]:BB:STEReo:GRPS:GT<st0>:UMT:NOENTries.....	81
[:SOURCE<hw>]:BB:STEReo:GRPS:GT<st0>:USRDate.....	81
[:SOURCE<hw>]:BB:STEReo:GRPS:GT<st0>:USRTime.....	82
[:SOURCE<hw>]:BB:STEReo:GRPS:GT<st0>:VERsion.....	82
[:SOURCE<hw>]:BB:STEReo:GRPS:PRESet.....	83
[:SOURCE<hw>]:BB:STEReo:GRPS:STORe.....	83
[:SOURCE<hw>]:BB:STEReo:PILOt:PHASe.....	56
[:SOURCE<hw>]:BB:STEReo:PILOt:STATe.....	56
[:SOURCE<hw>]:BB:STEReo:PILOt[DEVIation].....	56
[:SOURCE<hw>]:BB:STEReo:PRESet.....	51
[:SOURCE<hw>]:BB:STEReo:PUWSint.....	57
[:SOURCE<hw>]:BB:STEReo:SETTing:CATalog?.....	51
[:SOURCE<hw>]:BB:STEReo:SETTing:LOAD.....	51
[:SOURCE<hw>]:BB:STEReo:SETTing:STORe.....	52
[:SOURCE<hw>]:BB:STEReo:SETTing:STORe:FAST.....	52
[:SOURCE<hw>]:BB:STEReo:SOURce.....	53
[:SOURCE<hw>]:BB:STEReo:STATe.....	50
[:SOURCE<hw>]:BB:STEReo:TRIGger:RMODE.....	57
[:SOURCE<hw>]:BB:STEReo[TRIGger]:SEQUence.....	58

Index

A

Alternative Frequency List	31
Alternative Frequency List (ON)	36
Artificial Head	32, 68
Audio Level	21, 54
Audio Mode	20
Audio Source	17, 53
Auto	58

B

Block	44
Block 2	43
Block 3	43
Block 4	43

C

Compressed PTY	32, 68
Conventions	
SCPI commands	49

D

Data Rate	23
Data Set	23
RDS/RBDS	59
Date	34, 67, 78
Decoder Identification	42
Decoder Information	29, 32, 76
Default Settings	
FM-Stereo	16
Deviation	23
Pilot	56
RDS/RBDS	58
Do Conf	31
Documentation overview	5
Dynamic PTY	32, 69

E

Edit User Group	24
Edit User Message Table	30
Extended Configuration	29
Extended Generic Indicator (EG)	41, 69
External Clock	20, 54

F

File Manger	16
FM Deviation	17
Frequency	
Alternative Frequency List	33, 65, 67
Alternative Frequency List ON	39

G

Global Trigger/Clock Settings	46
Group Type	30
Group Type Number	30
Group Type Version	29
Groups Input Mehtod	24, 60

I

Input Method	28
International Linkage Set Indicator	41, 70

L

LF-Generator Frequency	20, 56
Linkage Actuator (LA)	40, 70
Linkage Set Number LSN	41
Load Audio File	20
Load FM-STEREO Settings	16
Load Hex Data	45
Local Offset Time	34, 71

M

Mapped Frequency	40
Mapped Frequency List	36
Marker	22
Mode	24
RDS/RBDS	60
Music/Voice Switch	32, 42, 73

N

No. of Message Entries	45
No. of Transmitted Groups	43
User Message Table	81
No. of Used Frequency	
Alternative Frequency List	33, 66, 67
Alternative Frequency List ON	39
Mapped Frequency List	40, 73

O

Open File Manager	16
-------------------------	----

P

Phase	23
Pilot	56
RDS/RBDS	60
Pilot Deviation	21
Pilot Phase	21
Pilot State	21
Preemphasis	21, 55
Preset Hex Table	44
Program Identification	25
Program Identification (ON)	36
Program Item Number (ON)	42
Program Service Name	33, 75
Program Service Name (ON)	39, 75
Program Type	27
Program Type Number	26
Program Type Number (ON)	41, 76

R

Radio Band	40
Radio Text	29, 65, 77, 79
RDS/RBDS ConfigurationEOEO	22
Recall Configuration	16
Recall FM-STEREO Settings	16

Running 46

S

Save Configuration 16
 Save FM-STEREO Settings 16
 Save Groups 25
 Select Group List 24
 Set Active Group to Default 64
 Set Groups to Default 25
 Set to Default
 FM-Stereo 16
 Settings Update 22
 Standard Settings
 FM-Stereo 16
 State 23
 AF method A 39, 66
 FM-Stereo 16
 Group Table 30, 78
 Linkage Information 40, 71
 Mapped Frequencies 39, 73
 Pilot 56
 PIN 42, 74
 Program Service 39, 76
 PTY/ TA 41, 77
 RDS/RBDS 61
 Stereo 33, 69
 Stopped 46
 System Date 34
 System Time 34, 78

T

Time 34, 80
 Traffic Announcement 32, 42, 79
 Traffic Announcement (ON) 42, 77, 79
 Traffic Program 27, 65
 Traffic Program (ON) 37, 80
 Transmit Time 30
 Group Table 80
 Trigger 22
 Trigger Mode 58
 Auto 46
 Tuning Frequency 40

U

User Date 34, 81
 User Marker / AUX I/O Settings 46
 User Time 34, 82

V

Version
 Group Type 82